

Air conditioner

User manual

PC4NUX*AN

- Thank you for purchasing this Samsung air conditioner.
- Before operating this unit, please read this manual carefully and retain it for future reference.



SAMSUNG

Contents

Safety Information	3
Safety Information	3
At a Glance	9
Indoor Unit Overview	9
Remote Control Overview	10
How to insert a remote control battery	10
Cleaning and Maintenance	11
Cleaning and Maintaining	11
Cleaning the indoor unit exterior • Cleaning the outdoor unit heat exchanger	11
Removing the air filter	12
Cleaning the air filter	13
Re-attaching the air filter	14
Resetting the filter • Technical specifications	15



**Correct Disposal of This Product
(Waste Electrical & Electronic Equipment)**

(Applicable in countries with separate collection systems)

This marking on the product, accessories or literature indicates that the product and its electronic accessories (e.g. charger, headset, USB cable) should not be disposed of with other household waste at the end of their working life. To prevent possible harm to the environment or human health from uncontrolled waste disposal, please separate these items from other types of waste and recycle them responsibly to promote the sustainable reuse of material resources. Household users should contact either the retailer where they purchased this product, or their local government office, for details of where and how they can take these items for environmentally safe recycling.

Business users should contact their supplier and check the terms and conditions of the purchase contract. This product and its electronic accessories should not be mixed with other commercial wastes for disposal.

For information on Samsung's environmental commitments and product-specific regulatory obligations, e.g. REACH, WEEE, Batteries, visit: www.samsung.com/uk/aboutsamsung/sustainability/environment/our-commitment/data/

Safety Information

Before using your new air conditioner, please read this manual thoroughly to ensure that you know how to safely and efficiently operate the extensive features and functions of your new appliance.





Because the following operating instructions cover various models, the characteristics of your air conditioner may differ slightly from those described in this manual. If you have any questions, call your nearest contact centre or find help and information online at www.samsung.com.

WARNING

Hazards or unsafe practices that may result in severe personal injury or death.

CAUTION

Hazards or unsafe practices that may result in minor personal injury or property damage.

-  Follow directions.
-  Do NOT attempt.
-  Make sure the machine is grounded to prevent electric shock.
-  Cut-off the power supply.
-  Do NOT disassemble.

FOR INSTALLATION

WARNING

-  **Use the power line with the power specifications of the product or higher and use the power line for this appliance only. In addition, do not use an extension line.**
 - Extending the power line may result in electric shock or fire.
 - Do not use an electric transformer. This may result in electric shock or fire.
 - If the voltage/frequency/rated current condition is different, it may cause fire.

Safety Information

- ❗ **The installation of this appliance must be performed by a qualified technician or service company.**
 - Failing to do so may result in electric shock, fire, explosion, problems with the product, or injury.
- Install a switch and circuit breaker dedicated to the air conditioner.
 - Failing to do so may result in electric shock or fire.
- ⊘ **Do not install this appliance near a heater, inflammable material. Do not install this appliance in a humid, oily or dusty location, in a location exposed to direct sunlight and water (rain drops). Do not install this appliance in a location where gas may leak.**
 - This may result in electric shock or fire.
- ⚡ **This appliance must be properly grounded. Do not ground the appliance to a gas pipe, plastic water pipe, or telephone line.**
 - Failure to do so may result in electric shock, fire, an explosion, or other problems with the product.
 - Make sure to use a socket-outlet with ground and make sure that it is in accordance with local and national codes.

⚠ CAUTION

- ❗ **Install the drain hose properly so that water is drained correctly.**
 - Failing to do so may result in water overflowing and property damage. Avoid adding drain to waste pipes as odours may arise in the future.

FOR POWER SUPPLY

⚠ WARNING

- ❗ **When the circuit breaker is damaged, contact your nearest service centre.**
- ⊘ **Do not pull or excessively bend the power line. Do not twist or tie the power line. Do not hook the power line over a metal object, place a heavy object on the power line, insert the power line between objects, or push the power line into the space behind the appliance.**
 - This may result in electric shock or fire.

 **CAUTION**

-  **When not using the air conditioner for a long period of time or during a thunder/lightning storm, cut the power at the circuit breaker.**
- Failing to do so may result in electric shock or fire.

FOR USING

 **WARNING**

-  **If the appliance is flooded, please contact your nearest service centre.**
- Failing to do so may result in electric shock or fire.

If the appliance generates a strange noise, a burning smell or smoke, cut-off the power supply immediately and contact the nearest service center.

- Failing to do so may result in electric shock or fire.

In the event of a gas leak (such as propane gas, LP gas, etc.), ventilate immediately without touching the power line. Do not touch the appliance or power line.

- Do not use a ventilating fan.
- A spark may result in an explosion or fire.

To reinstall the air conditioner, please contact your nearest service centre.

- Failing to do so may result in problems with the product, water leakage, electric shock, or fire.
- A delivery service for the product is not provided. If you reinstall the product in another location, additional construction expenses and an installation fee will be charged.
- Especially, when you wish to install the product in an unusual location such as in an industrial area or near the seaside where it is exposed to salt in the air, please contact your nearest service centre.

-  **Do not touch the circuit breaker with wet hands.**
- This may result in electric shock.

Do not turn the air conditioner off with the circuit breaker while it is operating.

- Turning the air conditioner off and then on again with the circuit breaker may cause a spark and result in electric shock or fire.

Safety Information

- ⊘ After unpacking the air conditioner, keep all packaging materials well out of the reach of children, as packaging materials can be dangerous to children.**
- If a child places a bag over its head, it may result in suffocation.
- Do not touch the front panel with your hands or fingers during the heating operation.**
- This may result in electric shock or burns.
- Do not insert your fingers or foreign substances into the outlet when the air conditioner is operating or the front panel is closing.**
- Take special care that children do not injure themselves by inserting their fingers into the product.
- Do not insert your fingers or foreign substances into the air inlet/outlet of the air conditioner.**
- Take special care that children do not injure themselves by inserting their fingers into the product.
- Do not strike or pull the air conditioner with excessive force.**
- This may result in fire, injury, or problems with the product.
- Do not use this air conditioner for long periods of time in badly ventilated locations or near infirm people.**
- Since this may be dangerous due to a lack of oxygen, open a window at least once an hour.
- ⊘ If any foreign substance such as water has entered the appliance, cut-off the power supply and contact the nearest service center.**
- Failing to do so may result in electric shock or fire.
- ⊘ Do not attempt to repair, disassemble, or modify the appliance yourself.**
- Do not use any fuse (such as copper, steel wire, etc.) other than the standard fuse.
 - Failing to do so may result in electric shock, fire, problems with the product, or injury.

 **CAUTION**

- ❗ **Do not place objects or devices under the indoor unit.**
 - Water dripping from the indoor unit may result in fire or property damage.

Max current is measured according to IEC standard for safety and current is measured according to ISO standard for energy efficiency.

- ⊘ **Do not operate the appliance with wet hands.**
 - This may result in electric shock.

Do not spray volatile material such as insecticide onto the surface of the appliance.

- As well as being harmful to humans, it may also result in electric shock, fire or problems with the product.

Do not drink the water from the air conditioner.

- The water may be harmful to humans.

Do not apply a strong impact to the remote controller and do not disassemble the remote controller.

Do not touch the pipes connected with the product.

- This may result in burns or injury.

Do not use this air conditioner to preserve precision equipment, food, animals, plants or cosmetics, or for any other unusual purposes.

- This may result in property damage.

Avoid directly exposing humans, animals or plants to the air flow from the air conditioner for long periods of time.

- This may result in harm to humans, animals or plants.

Safety Information

- ⊘ This appliance is not intended for use by persons (including children) with reduced physical, sensory or mental capabilities, or lack of experience and knowledge, unless they have been given supervision or instruction concerning use of the appliance by a person responsible for their safety. Children should be supervised to ensure that they do not play with the appliance.

For use in Europe: This appliance can be used by children aged from 8 years and above and persons with reduced physical, sensory or mental capabilities or lack of experience and knowledge if they have been given supervision or instruction concerning use of the appliance in a safe way and understand the hazards involved. Children shall not play with the appliance. Cleaning and user maintenance shall not be made by children without supervision.

FOR CLEANING

WARNING

- ⊘ Do not clean the appliance by spraying water directly onto it. Do not use benzene, thinner, alcohol or acetone to clean the appliance.
 - This may result in discoloration, deformation, damage, electric shock or fire.

Before cleaning or performing maintenance, cut-off the power supply and wait until the fan stops.

- Failing to do so may result in electric shock or fire.

CAUTION

- ⊘ Do not clean the inside of the air conditioner by yourself.
 - For cleaning inside the appliance, contact your nearest service centre.
 - When cleaning the internal filter, refer to the descriptions in the 'Cleaning and Maintaining' section.
 - Failure to do so may result in damage, electric shock or fire.

Indoor Unit Overview

The indoor unit and its display may look slightly different from the illustration shown below, depending on the model and the panel type. The purification panel is optionally installed to purify air in an enclosed space.

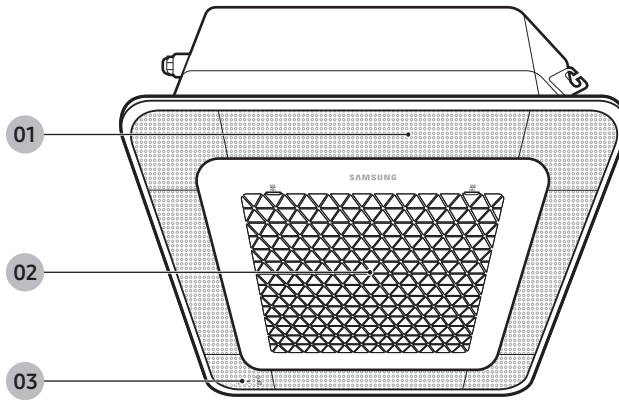

01 Air flow blade/Air outlet (inside) / Wind-Free panel (You can use the Wind-Free Cooling function when the Cool, Dry, or Fan mode is running.) (Refer to the remote control manual for product operation)

NOTE

- Each of the air flow blades can be controlled separately. Refer to the remote control manual for product operation.

02 Air intake / Air filter (under the grille)

03 Display

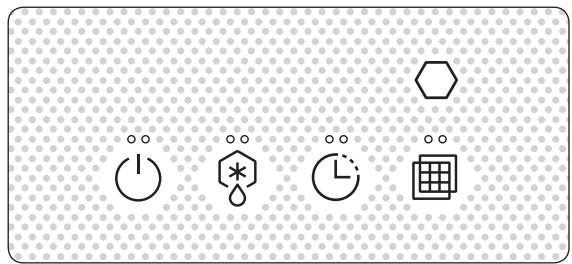

Indication	Function
	On/Off operation indicator
	Removing frost indicator
	Timer indicator
	Filter cleaning indicator
	Remote control sensor

Remote Control Overview

During installation or filter cleaning, you can use the dedicated remote control to raise or lower the grille of the lift grille-type indoor unit.

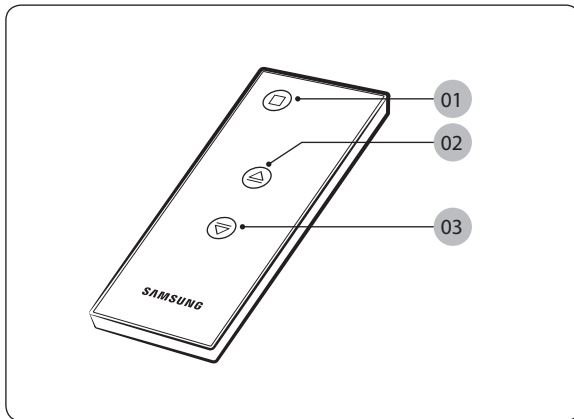

- 01 Stop button
- 02 Grille Up button
- 03 Grille Down button

NOTE

- Exercise caution to ensure that the remote control does not contact liquid.
- If you install the product with the grille lowered and then connect the power, the grille automatically moves up.
- If you press the [Grille Down] button, the grille moves down the specified length and automatically stops moving. To stop the grille from moving, press the [Stop] button.

How to insert a remote control battery

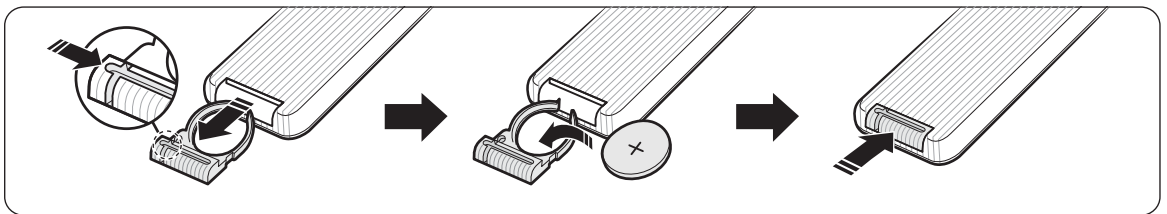

Cleaning and Maintaining

⚠ Before cleaning the indoor unit, be sure to turn off the auxiliary power switch.

Cleaning the indoor unit exterior

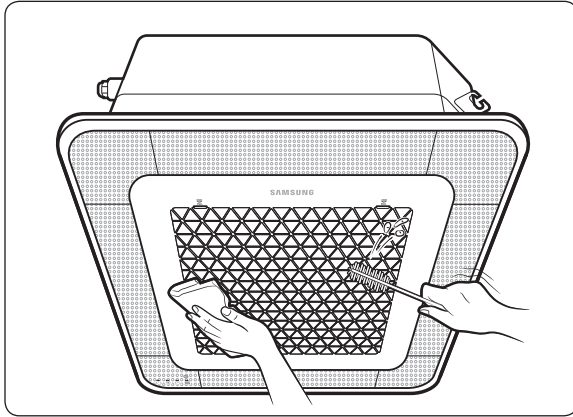

Wipe the surface of the unit with a slightly wet or dry cloth when needed. Wipe off dirt of odd-shaped areas by using a soft brush.

⚠ CAUTION

- Do not use alkaline detergent, sulphuric acid, hydrochloric acid, or organic solvents (such as thinner, kerosene, and acetone) to clean the surfaces.
- Do not attach any stickers on the surfaces because this may cause damage.
- When you clean the heat exchanger on the indoor unit, you need to disassemble the indoor unit. Therefore, you must contact the local service center for help.

Cleaning the outdoor unit heat exchanger

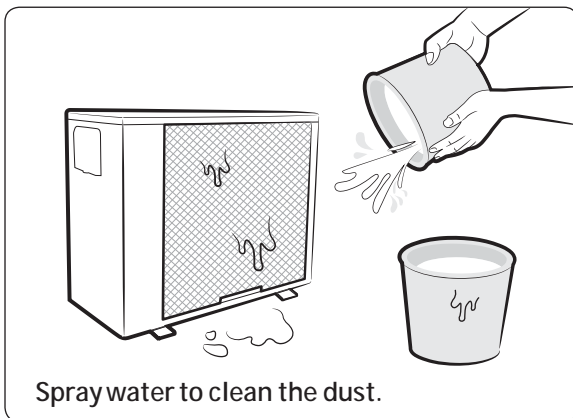

Spray water to clean the dust.

⚠ CAUTION

- The heat exchanger of the outdoor unit has sharp edges. Take care when cleaning its surface.

📖 NOTE

- If it is difficult to clean the heat exchanger of the outdoor unit, contact the local service center.

Cleaning and Maintaining

Removing the air filter

CAUTION

- Be sure to hold the grille with a hand to prevent dropping from the opening of the front grille.

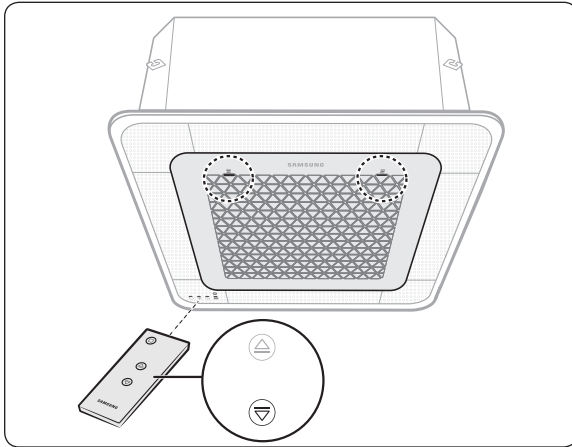

Press the [Grille Down] button to move down the grille.

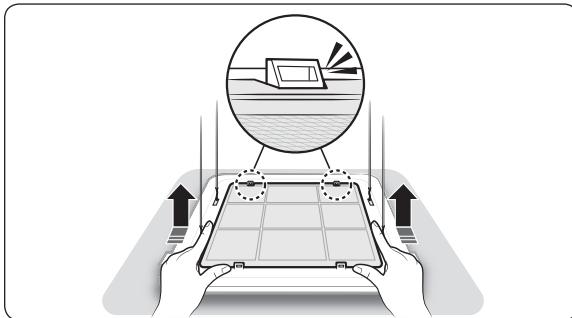
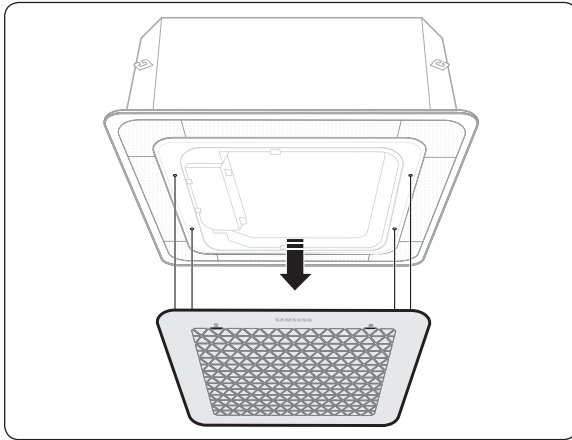

Pull out the air filter from the grille.

NOTE

- Before lowering the grille, confirm that there is no person or obstacle in the vicinity.
- Dust may fall when you lower the grille. Be careful.
- After the grille is lowered, ensure objects are not placed on the grille and children do not climb onto the grille.

NOTE

- The cleaning period may differ depending on the usage and environmental conditions, so clean the air filter every week if the indoor unit is in the dusty area.
- Clean the indoor unit exterior when cleaning the filters.

Cleaning the air filter

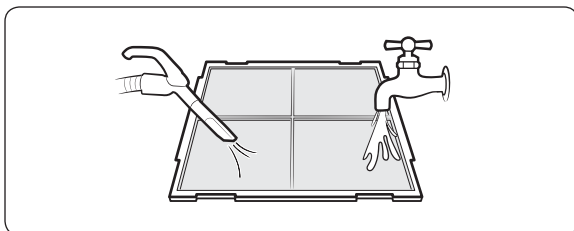

Clean the air filter with a vacuum cleaner or soft brush. If dust is too heavy, then rinse it with running water and dry it in a ventilated area.

CAUTION

- Do not scrub the air filter with a brush or other cleaning utensil. This may damage the filter.

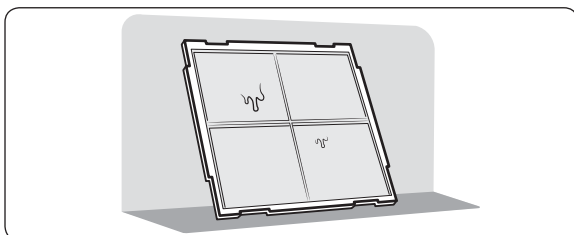

Leave it for more than 12 hours in shade to completely dry it.

NOTE

- Clean the air filter once every two weeks (on an 8-hour daily use basis).

Cleaning and Maintaining

Re-attaching the air filter

NOTE

- Re-attach the filter in reverse order of removal.

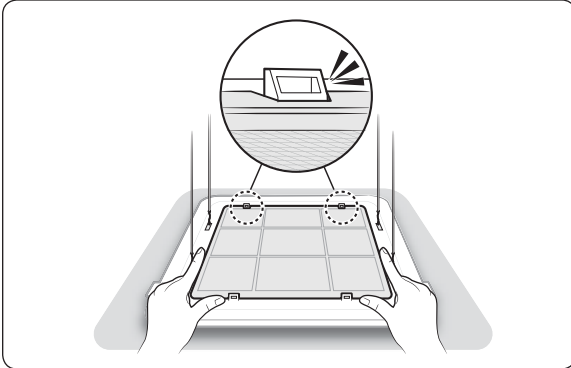

NOTE

- After re-attaching the dust filter, press the [Grille Up] button on the remote control dedicated for the auto-lift grille to close the grille.
- If the angle of the airflow blade has changed during removal or re-attachment, turn the auxiliary power switch off and on again.

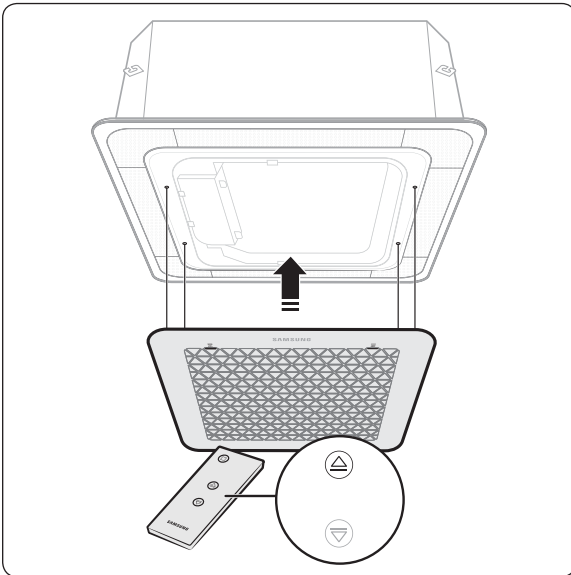

Resetting the filter

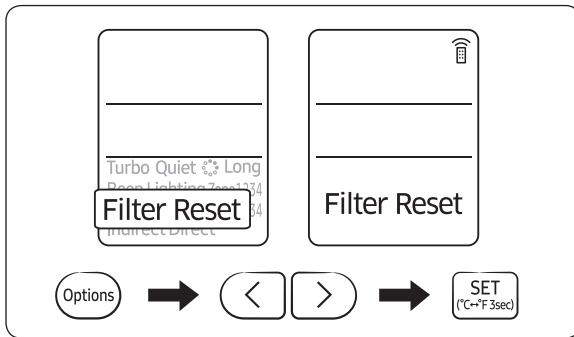
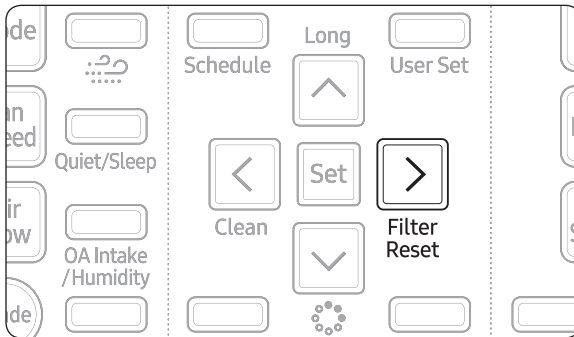

After cleaning and reassembling the air filter, be sure to reset the filter-cleaning reminder as follows:

- Indoor unit with the wired remote control: Press the **Filter Reset** button.
- Indoor unit with the wireless remote control: Press the **Options** button → < or > → (**Filter Reset**) Blinking → press the **SET** button.

NOTE

- The filter reset indicator blinks when the air filter should be cleaned.
- Although the filter cleaning indicator (📺) does not light, be sure to press the "Filter Reset" button after cleaning the air filter.
- If the angle of the air flow blade is changed by opening the front grille for installation or maintenance of the indoor unit, be sure to turn off and then on the auxiliary switch before operating the indoor unit again. If not, the angle of the air flow blade may be changed and the blades may not be closed after turning off the indoor unit.

Technical specifications

Model	Net weight	Net dimension (W x D x H)
PC4NUXMAN	8.0 Kg	950 x 950 x 48

QUESTIONS OR COMMENTS?

COUNTRY	CALL	OR VISIT US ONLINE AT
UK	0333 000 0333	www.samsung.com/uk/support
IRELAND (EIRE)	0818 717100	www.samsung.com/ie/support
GERMANY	06196 77 555 77	www.samsung.com/de/support
FRANCE	01 48 63 00 00	www.samsung.com/fr/support
SPAIN	91 175 00 15	www.samsung.com/es/support
PORTUGAL	808 207 267	www.samsung.com/pt/support
LUXEMBURG	261 03 710	www.samsung.com/be_fr/support
NETHERLANDS	088 90 90 100	www.samsung.com/nl/support
BELGIUM	02-201-24-18	www.samsung.com/be/support (Dutch) www.samsung.com/be_fr/support (French)
NORWAY	21629099	www.samsung.com/no/support
DENMARK	707 019 70	www.samsung.com/dk/support
FINLAND	030-6227 515	www.samsung.com/fi/support
SWEDEN	0771 726 786	www.samsung.com/se/support
AUSTRIA	0800 72 67 864 (0800-SAMSUNG)	www.samsung.com/at/support
SWITZERLAND	0800 726 786	www.samsung.com/ch/support (German) www.samsung.com/ch_fr/support (French)
HUNGARY	0680SAMSUNG (0680-726-7864)	www.samsung.com/hu/support
CZECH	800 - SAMSUNG (800-726786)	www.samsung.com/cz/support
SLOVAKIA	0800 - SAMSUNG (0800-726 786)	www.samsung.com/sk/support
CROATIA	072 726 786	www.samsung.com/hr/support
BOSNIA	055 233 999	www.samsung.com/ba/support
North Macedonia	023 207 777	www.samsung.com/mk/support
MONTENEGRO	020 405 888	www.samsung.com/support
SLOVENIA	080 697 267 (brezplačna številka)	www.samsung.com/si/support
SERBIA	011 321 6899	www.samsung.com/rs/support
KOSOVO	0800 10 10 1	www.samsung.com/support
ALBANIA	045 620 202	www.samsung.com/al/support
BULGARIA	*3000 Цена на един зрагски разговор 0800 111 31 Безплатен за Всички оператори	www.samsung.com/bg/support
ROMANIA	*8000 (apel in retea) 08008-726-78-64 (08008-SAMSUNG) Apel GRATUIT Atenție: Dacă efectuați apelul din rețeaua Digi (RCS/RDS), vă rugăm să ne contactați formând numărul Telverde fără ultimele două cifre, astfel: 0800872678.	www.samsung.com/ro/support
ITALIA	800-SAMSUNG (800.7267864)	www.samsung.com/it/support
CYPRUS	8009 4000 only from landline, toll free	www.samsung.com/gr/support
GREECE	80111-SAMSUNG (80111 726 7864) only from land line (+30) 210 6897691 from mobile and land line	
POLAND	801-172-678* lub +48 22 607-93-33* * (optata według taryfy operatora)	http://www.samsung.com/pl/support/
LITHUANIA	8-800-7777	www.samsung.com/lt/support
LATVIA	8000-7267	www.samsung.com/lv/support
ESTONIA	800-7267	www.samsung.com/ee/support

Samsung, PO Box 12987, Blackrock, Co. Dublin. Ireland
or Blackbushe Business Park, Yateley, GU46 6GG. UK

