

ES

TERMOSTATO RADIO SIMPLIFICADO AIRZONE LITE

Termostato con botones capacitivos y acabado en acero y cristal, para el control de temperatura de zona en un sistema Airzone. Comunicaciones vía radio. Alimentado mediante batería de botón CR2450. Disponible en blanco y negro.

Funcionalidades:

- On/Off de la zona.
- Control de temperatura de consigna, en pasos de 1°C, hasta un máximo de $\pm 3^{\circ}\text{C}$.
- Lectura de la temperatura ambiente y humedad relativa.

Para más información de nuestros productos remítase a myzone.airzone.es

EN

AIRZONE LITE THERMOSTAT WIRELESS

Thermostat with capacitive buttons for controlling the temperature of the zones in Airzone systems. Finished in steel and glass. Wireless communications. Powered by CR2450 button battery. Available in white and black.

Functionalities:

- On/off of the zone.
- Set-point temperature control (Accuracy: $\pm 1^{\circ}\text{C}$, up to a limit of $\pm 3^{\circ}\text{C}$.)
- Room temperature and relative humidity reading.

For further information about our products, go to myzone.airzone.es.

PT

TERMOSTATO RÁDIO SIMPLIFICADO AIRZONE LITE

Termostato com botões capacitivos e acabamento em aço e cristal para controlo de temperatura de zona em sistema Airzone. Comunicação via rádio. Alimentado através de bateria de botão CR2450. Disponível em branco e preto.

Funcionalidades:

- On/Off da zona.
- Controlo de temperatura de referência, em intervalos de 1°C, até máximo de $\pm 3^{\circ}\text{C}$.
- Leitura da temperatura ambiente e humidade relativa.

Para obter mais informações sobre nossos produtos, consulte myzone.airzone.pt

AZCE6LITER [B/N]

AIRZONE

- Flexa 3.0
- Innobus Pro6



ES EN PT

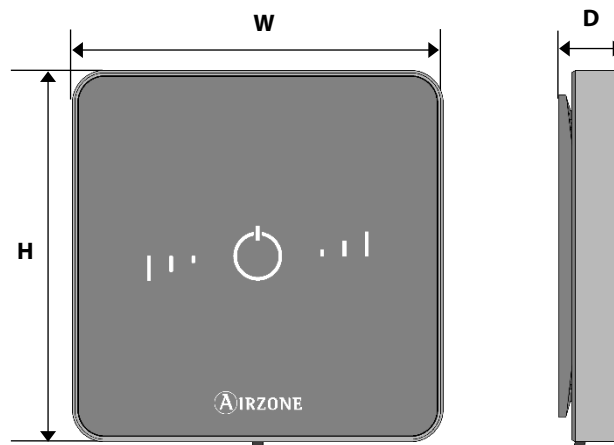

(ES) CARACTERÍSTICAS TÉCNICAS / (EN) TECHNICAL SPECS / (PT) CARACTERÍSTICAS TÉCNICAS

Alimentación y consumo / Power supply and consumption Alimentação e consumo	
Tipo de alimentación / Type of power supply / Tipo de alimentação	Vdc
	V max 3,3 V
	I max 30 mA
Batería / Battery / Bateria	CR2450
Vida útil (estimada) de la batería / Useful Life (estimated) of battery Vida útil (estimada) da bateria	2 años 2 years 2 anos
Consumo Stand-by / Stand-by consumption / Consumo em stand-by	0,01 mW
Conexión y comunicaciones / Connection and communications Conexão e comunicação	
Frecuencia de comunicación / Communication frequency Frequência de comunicação	868 MHz
Potencia máxima / Maximum power / Potência máxima	0 dBm
Distancia máxima en espacio libre / Maximum distance in open space / Distância máxima em espaço livre	40 m
Temperaturas operativas / Operating temperatures Temperatura de operação	
Almacenaje / Storage / Armazenamento	-20 ... 70 °C
Funcionamiento / Operation / Funcionamento	0 ... 50°C
Rango de humedad de funcionamiento/ Operating humidity range / Intervalo de humidade de funcionamento	5...90% (sin condensación) (non-condensing) (sem condensação)
Rango de temperatura de consigna / Set-point temperature range / Intervalo da temperatura de referência	15 ... 30°C
Precisión de lectura / Reading accuracy Precisão de leitura	$\pm 0,1^{\circ}\text{C}$
Humedad relativa / Relative humidity / Humidade relativa	$\pm 4\%$
Aspectos mecánicos / Mechanical aspects / Aspectos mecânicos	
Montaje / Assembly / Montagem	En superficie mediante soporte Surface through support Em superfície mediante suporte
Grado de protección / Protection class / Grau de proteção	IP 20
Tipo de sonda / Type of probe / Tipo de sonda	Airzone_NTC_10K
	Peso / Weight / Peso 184 g
Dimensiones / Dimensions / Dimensões (WxHxD)	92x 92x15,85 mm





(ES) MONTAJE Y CONEXIÓN / (EN) ASSEMBLY AND CONNECTION / (PT) MONTAGEN E CONEXÃO

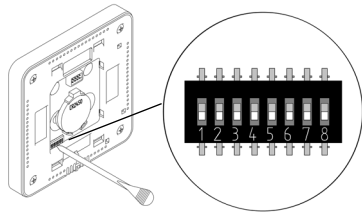

(ES) Seleccione la zona a controlar mediante el microswitch.

(EN) Select the zone to be controlled through microswitch.

(PT) Seleccione a zona a ser controlada através do microinterruptor.

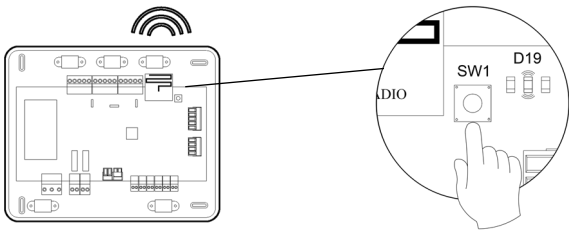
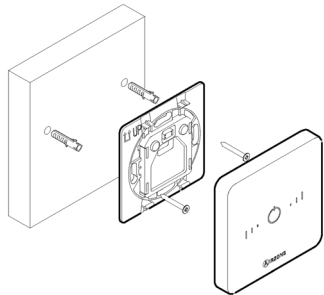

Significado / Meaning / Significado		
	5 parpadeos verde Blinking green 5 times 5 piscadas verdes	Asociación correcta Correct association Associação correta
	1 parpadeo rojo Blinking red once 1 piscada vermelha	Zona ocupada Occupied zone Zona ocupada
	2 parpadeos rojo Blinking red twice 2 piscadas vermelhas	Termostato fuera de cobertura Thermostat out of range Termostato fora de cobertura

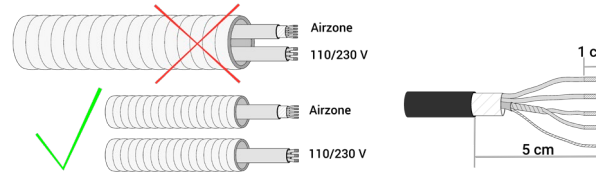
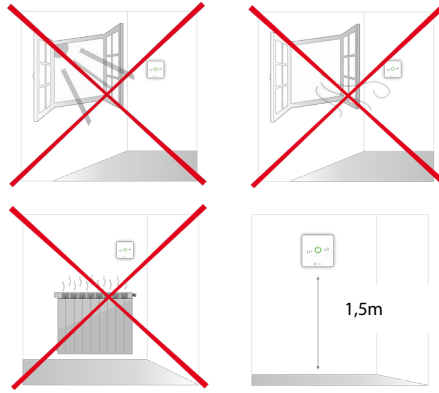

(ES) AUTODIAGNÓSTICO / (EN) SELF-DIAGNOSIS / (PT) AUTODIAGNÓSTICO

Significado / Meaning / Significado		
	Parpadeo rápido rojo Blinking red quickly Piscadas vermelhas rápidas	Error de comunicaciones con la central Error of communication with main control board Erro de comunicação com a central



(ES) CAMBIO BATERÍA/ (EN) CHANGING BATTERIES / (PT) TROCA DE BATERIA

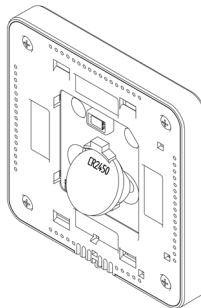

(ES) Se recomienda el uso de baterías de primeras marcas, similares a las suministradas. Una batería de menor calidad puede reducir la vida útil de esta.

(EN) We recommend using of top-brand batteries. Using low-quality batteries may reduce the duration of use.

(PT) Recomendamos a utilização de baterias de alta qualidade, sem elhantes às fornecidas. Baterias de qualidade inferior podem reduzir a vida útil do dispositivo.



(ES) FUNCIONALIDADES / (EN) FUNCTIONALITIES / (PT) FUNCIONALIDADES

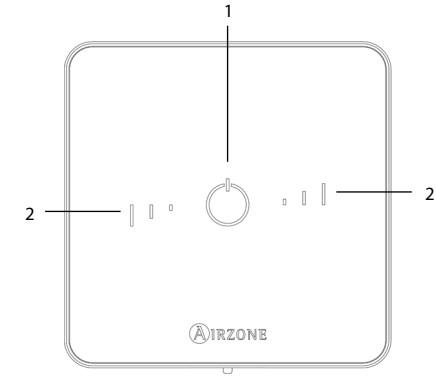

Nº	Significado / Meaning / Significado	
1	<p>Si el led está fijo la zona está encendida If the LED is fixed, the zone is activated Se o led está fixo, a zona está ativa</p> <p>Si el led está parpadeando la zona está apagada If the LED is flashing the zone is deactivated Se o led estiver piscando, a zona está desativada</p>	<p>Modo de funcionamiento: - Morado: Stop - Rojo: Calor - Azul: Frío, Seco o Ventilación - Verde: Consigna</p> <p>Operation mode: - Purple: Stop - Red: Heating - Blue: Cooling, dry or ventilation - Green: Set-point</p> <p>Modo de funcionamento: - Roxo: parado - Vermelho: calor - Azul: frio, seco ou ventilação - Verde: referência</p>
2	<p>Si el led está encendido indica desfase de la temperatura de consigna con respecto a la temperatura base (1 led = ±1°C) If the led is on, it indicates there is a temperature gap between the set-point temperature and the base temperature (1 led = ±1°C) Se o led estiver aceso, existe um desfazamento da temperatura de referência em relação à temperatura base (1 led = ±1°C)</p> <p>Si el led parpadea indica que ha llegado a la temperatura límite establecido por el Eco-Adapt If the led blinking it, indicates it has reached the temperature limit set by the Eco-Adapt function Se o led piscar, a temperatura limite estabelecida pelo Eco-Adap foi atingida</p>	

FR THERMOSTAT AIRZONE LITE RADIO

Thermostat disposant de touches capacitives et finition en acier et en verre, pour le contrôle de la température d'une zone dans un système Airzone. Communications via radio. Alimenté au travers d'une pile bouton CR2450. Disponible en noir et en blanc.

Fonctionnalités :

- On / Off de la zone.
- Modification de la température de consigne déjà assignée par pas de 1°C, jusqu'à un maximum de $\pm 3^{\circ}\text{C}$.
- Lecture de la température ambiante et de l'humidité relative.

Pour plus d'informations sur nos produits, veuillez vous rendre sur la page myzone.airzonefrance.fr

IT TERMOSTATO AIRZONE LITE RADIO

Termostato con tasti capacitivi e finitura in acciaio e vetro per il controllo della temperatura in un sistema Airzone. Comunicazione via radio con la scheda centrale. Alimentazione mediante batteria CR2450. Disponibile nei colori bianco e nero.

Funzionalità:

- On/Off della zona.
- Controllo della temperatura desiderata con passo di 1°C fino a un massimo di $\pm 3^{\circ}\text{C}$.
- Lettura della temperatura ambiente e dell'umidità relativa.

Per maggiori informazioni sui nostri prodotti utilizzi il nostro sito dedicato myzone.airzoneitalia.it

DE FUNK-THERMOSTAT EINFACH AIRZONE LITE

Thermostat mit berührungsempfindlichen Tasten, Ausführung in Stahl und Glas, für die Bereichssteuerung in Airzone-Systemen. Verbindung über Funk. Versorgung mittels Knopfzelle CR2450. Lieferbar in Schwarz oder Weiß.

Funktionsumfang:

- Ein/Aus des Bereichs.
- Steuerung der Solltemperatur in Schritten von 1°C bis max. $\pm 3^{\circ}\text{C}$.
- Ablesen der Raumtemperatur und relativen Luftfeuchtigkeit.

Weitere Informationen über unsere Produkte siehe myzone.airzone.es

AZCE6LITER [B/N]



- Flexa 3.0
- Innobus Pro6

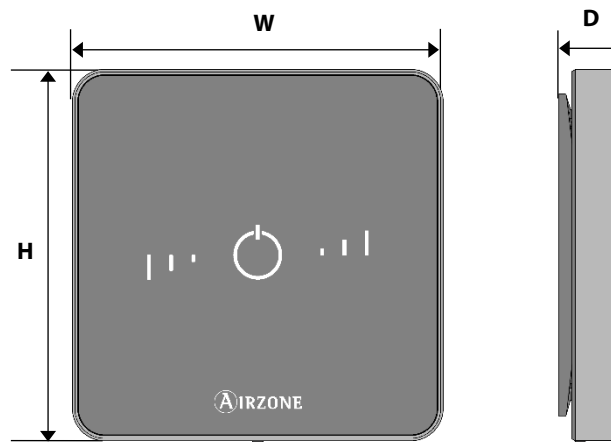

(FR) CARACTERISTIQUES TECHNIQUES (IT) CARATTERISTICHE TECNICHE (DE) TECHNISCHE DATEN

Alimentation et consommation / Alimentazione e consumo Stromversorgung und Verbrauch	
Type d'alimentation / Tipo di alimentazione/ Versorgungsart	Vdc
	V max 3,3 V
	I max 30 mA
	Batterie / Batteria / Batterie CR2450
Durée de vie (estimée) de la pile / Ciclo di vita (stimato) della batteria (Geschätzte Nutzungsdauer der Batterie)	2 années 2 anni 2 Jahre
Consommation Stand-by / Consumo Stand-by Stand-by-Leistungsaufnahme	0,01mW
Connexions et communications / Collegamenti e comunicazione Anschluss und Verbindungen	
Fréquence de communication / Frequenza di comunicazione Kommunikationsfrequenz	868 MHz
Puissance de radiation / Potenza massima / Max. Leistung	0dBm
Distance maximale en champ libre / Distanza massima in campo aperto / Max. Abstand im freien Raum	40 m
Températures opératives / Temperature operative Betriebstemperaturen	
De stockage / Stoccaggio / Lagerung	-20 ... 70 °C
De fonctionnement / Funzionamento / Betrieb	0 ... 50°C
Plage d'humidité de fonctionnement / Rango di umidità di funzionamento / Zulässige Luftfeuchtigkeit	5...90% (sans condensation) (senza condensazione) (nicht-kondensierend)
Plage de température de consigne / Rango di temperature impostabile / Solltemperaturbereich	15 ... 30°C
Précision de lecture / Precisione di lettura Ablesegenauigkeit	$\pm 0,1^{\circ}\text{C}$
Humidité relative / Umidità relativa Relative Luftfeuchtigkeit	$\pm 4\%$
Aspects mécaniques / Aspetti meccanici / Mechanische Aspekte	
Montage / Montaggio / Montage	En surface au moyen d'un support In superficie mediante supporto Oberfläche mittels Halterung
Degré de protection/ Grado di protezione / Schutzklasse	IP 20
Type de sonde / Tipo di sonda / Sondentyp	Airzone_NTC_10K
Poids / Peso / Gewicht	184 g
Dimensions / Dimensioni / Abmessungen (WxHxD)	92x 92x15,85 mm





(FR) MONTAGE ET CONNEXION / (IT) MONTAGGIO E COLLEGAMENTI / (DE) MONTAGE UND VERBINDUNG

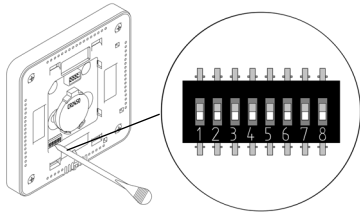

(FR) Sélectionnez la zone à contrôler au moyen du microswitch.

(IT) Selezionare il numero di zona da controllare mediante microswitch.

(DE) Wählen Sie den zu steuernden Bereich über den Mikroschwitch aus.

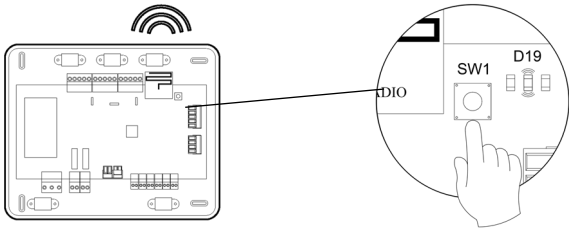
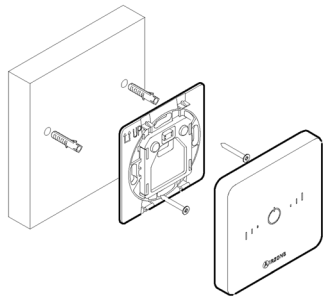

Signification / Significato / Bedeutung		
	5 clignotements verts 5 lampeggi verdi 5 mal Blinken grün	Association correcte Associazione corretta Kopplung erfolgt
	1 clignotement rouge 1 lampeggio rosso 1 mal Blinken rot	Zone occupée Zona occupata Bereich besetzt
	2 clignotements rouges 2 lampeggi rossi 2 mal Blinken rot	Thermostat hors réseau Termostato fuori copertura radio Thermostat außer Reichweite

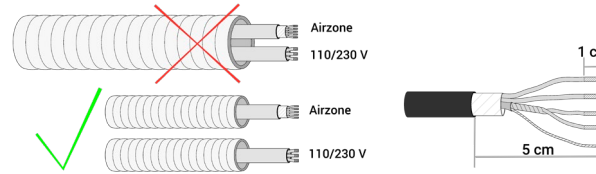
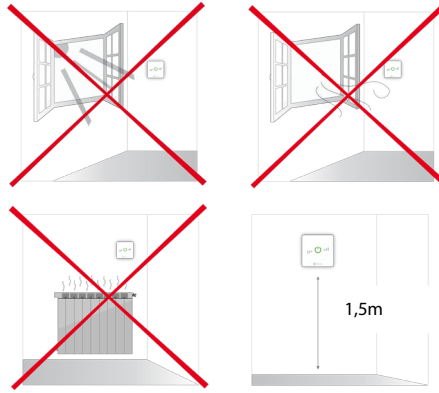

(FR) AUTODIAGNOSTIC / (IT) AUTODIAGNOSI (DE) SELBSTDIAGNOSE

Signification / Significato / Bedeutung		
	Clignotement rapide rouge lampeggio rapido rosso Schnelles Blinken rot	Erreur de communication avec la platine centrale Errore di comunicazione con la centrale Fehler Kommunikation mit Zentrale



(FR) CHANGEMENT DE LA PILE / (IT) CAMBIO BATTERIA / (DE) BATTERIEWECHSEL

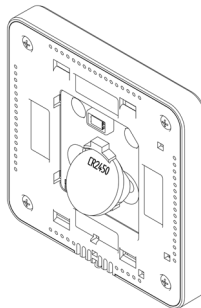

(FR) Il est recommandé l'utilisation de batteries de grande marque. Une pile d'inférieur qualité peut réduire la vie utile de celle-ci.

(IT) Si raccomanda di utilizzare batterie dei principali marchi, simili a quelli forniti. Se si utilizza una batteria di qualità inferiore potrebbe ridurre la vita utile della stessa.

(DE) Es wird empfohlen, erstklassige Markenbatterien, ähnlich wie die mitgelieferte Batterien, zu verwenden. Eine Batterie niedrigerer Qualität kann die Nutzungsdauer verringern.



(FR) FONCTIONNALITES / (IT) FUNZIONALITA' (DE) FUNKTIONSUMFANG

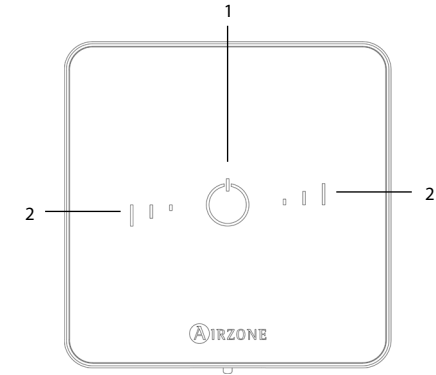

N°	Signification / Significato / Bedeutung	
1	Si la LED est fixe, la zone est activée Se il led è fisso la zona è accesa Wenn die LED fest leuchtet, ist der Bereich eingeschaltet	Mode de fonctionnement : - Violet : Stop - Rouge : Chauffage - Bleu : Refroidissement, déshumidification ou ventilation - Vert : Consigne Modo di funzionamento: - Vioa: Stop - Rosso: Caldo - Blu: Freddo, deumidificazione o ventilazione - Verde: Temperatura raggiunta Funktionsmodus: - Violett: Stopp - Rot: Wärme - Blau: Kalt, trocken oder Lüftung - Grün: Sollwert
	Si la LED clignote, la zone est désactivée Se il led lampeggia la zona è spenta Wenn die LED blinkt, ist der Bereich ausgeschaltet	
2	Si la LED est allumée, elle indique une variation de la température de consigne par rapport à la température de base (1 LED = ±1°C) Se il led è acceso indica un settaggio della temperatura richiesta rispetto alla temperatura base (1 led = ±1°C) Wenn die LED leuchtet, wird Abweichung zwischen Solltemperatur und Grundtemperatur angezeigt (1 led = ±1°C)	
3	Si la LED clignote, elle indique que la zone est arrivée à la température limite établie par la fonction Eco-Adapt. Se il led lampeggia indica che si è raggiunta la temperatura limite impostabile da Eco-Adapt Wenn die LED blinkt, wird angezeigt, dass die vom Eco-Adapt festgelegte Grenztemperatur erreicht ist	