

Air conditioner

Installation manual

AC***RXAD*G

- Thank you for purchasing this Samsung air conditioner.
- Before operating this unit, please read this manual carefully and retain it for future reference.



SAMSUNG

Contents

Safety Information	4
General information	4
Installing the unit	5
Power supply line, fuse or circuit breaker	6
Installation Procedure	7
Step 1 Choosing the installation location	7
Step 2 Fixing the outdoor unit in place	10
Step 3 Connecting the power cables, communication cable, and controllers	11
Step 4 Optional: Extending the power cable	17
Step 5 Connecting the refrigerant pipe	19
Step 6 Optional: Cutting and flaring the pipes	20
Step 7 Installing oil traps	21
Step 8 Connecting up and removing air in the circuit	22
Step 9 Adding refrigerant (R-32)	23
Step 10 Performing the gas leak test	26
Step 11 Connecting the drain hose to the outdoor unit	27
Step 12 Insulating the refrigerant pipes	27
Step 13 Checking the earthing	28
Step 14 Performing final check and trial operation	29
Extra procedures	32
Pumping down refrigerant	32
Relocating the indoor and outdoor units	32
Using the stop valve	33

Maintenance Procedures

34

Performing the gas leak tests for repair

34

Decommissioning

34

Appendix

35

Troubleshooting

35

Technical specifications

36

COMMISSION DELEGATED REGULATION (EU) No 626/2011¹⁾

37



Correct Disposal of This Product (Waste Electrical & Electronic Equipment)

(Applicable in countries with separate collection systems)

This marking on the product, accessories or literature indicates that the product and its electronic accessories (e.g. charger, headset, USB cable) should not be disposed of with other household waste at the end of their working life. To prevent possible harm to the environment or human health from uncontrolled waste disposal, please separate these items from other types of waste and recycle them responsibly to promote the sustainable reuse of material resources.

Household users should contact either the retailer where they purchased this product, or their local government office, for details of where and how they can take these items for environmentally safe recycling.

Business users should contact their supplier and check the terms and conditions of the purchase contract. This product and its electronic accessories should not be mixed with other commercial wastes for disposal.

For information on Samsung's environmental commitments and product-specific regulatory obligations, e.g. REACH, WEEE, Batteries, visit : samsung.com/uk/aboutsamsung/samsungelectronics/corporatecitizenship/data_corner.html

Safety Information

WARNING

- Hazards or unsafe practices that may result in severe personal injury or death.

CAUTION

- Hazards or unsafe practices that may result in minor personal injury or property damage.

Carefully follow the precautions listed below because they are essential to guarantee the safety of the equipment.

WARNING

- Always disconnect the air conditioner from the power supply before servicing it or accessing its internal components.
- Verify that installation and testing operations are performed by qualified personnel.
- Verify that the air conditioner is not installed in an easily accessible area.

General information

WARNING

- Carefully read the content of this manual before installing the air conditioner and store the manual in a safe place in order to be able to use it as reference after installation.
- For maximum safety, installers should always carefully read the following warnings.
- Store the operation and installation manual in a safe location and remember to hand it over to the new owner if the air conditioner is sold or transferred.
- This manual explains how to install an indoor unit with a split system with two SAMSUNG units. The use of other types of units with different control systems may damage the units and invalidate the warranty. The manufacturer shall not be responsible for damages arising from the use of non compliant units.
- The manufacturer shall not be responsible for damage originating from unauthorized changes or the improper connection of electric and requirements set forth in the "Operating limits" table, included in the manual, shall immediately invalidate the warranty.
- The air conditioner should be used only for the applications for which it has been designed: the indoor unit is not suitable to be installed in areas used for laundry.
- Do not use the units if damaged. If problems occur, switch the unit off and disconnect it from the power supply.
- In order to prevent electric shocks, fires or injuries, always stop the unit, disable the protection switch and contact SAMSUNG's technical support if the unit produces smoke, if the power cable is hot or damaged or if the unit is very noisy.
- Always remember to inspect the unit, electric connections, refrigerant tubes and protections regularly. These operations should be performed by qualified personnel only.
- The unit contains moving parts, which should always be kept out of the reach of children.
- Do not attempt to repair, move, alter or reinstall the unit. If performed by unauthorized personnel, these operations may cause electric shocks or fires.
- Do not place containers with liquids or other objects on the unit.
- All the materials used for the manufacture and packaging of the air conditioner are recyclable.
- The packing material and exhaust batteries of the remote controller(optional) must be disposed of in accordance with current laws.
- The air conditioner contains a refrigerant that has to be disposed of as special waste. At the end of its life cycle, the air conditioner must be disposed of in authorized centres or returned to the retailer so that it can be disposed of correctly and safely.
- Do not use means to accelerate the defrost operation or to clean, other than those recommended by Samsung.
- Do not pierce or burn.
- Be aware that refrigerants may not contain an odour.
- This appliance is not intended for use by persons (including children) with reduced physical, sensory or mental capabilities, or lack of experience and knowledge, unless they have been given supervision or instruction concerning use of the appliance by a person responsible for their safety. Children should be supervised to ensure that they do not play with the appliance.

- **For use in Europe:** This appliance can be used by children aged from 8 years and above and persons with reduced physical, sensory or mental capabilities or lack of experience and knowledge if they have been given supervision or instruction concerning use of the appliance in a safe way and understand the hazards involved. Children shall not play with the appliance. Cleaning and user maintenance shall not be made by children without supervision.

Installing the unit



WARNING

IMPORTANT: When installing the unit, always remember to connect first the refrigerant tubes, then the electrical lines.

- Upon receipt, inspect the product to verify that it has not been damaged during transport. If the product appears damaged, DO NOT INSTALL it and immediately report the damage to the carrier or retailer (if the installer or the authorized technician has collected the material from the retailer.)
- After completing the installation, always carry out a functional test and provide the instructions on how to operate the air conditioner to the user.
- Do not use the air conditioner in environments with hazardous substances or close to equipment that release free flames to avoid the occurrence of fires, explosions or injuries.
- Do not install the product in a place where thermohygrostat is needed (such as server room, machinery room, computer room, etc.) Those places do not provide guaranteed operation condition of the product therefore performance can be poor in these places.
- Do not install the product in a ship or a vehicle (such as a campervan). Salt, vibration or other environmental factor may cause the product malfunction, electric shock or fire.
- Our units should be installed in compliance with the spaces shown in the installation manual, to ensure accessibility from both sides and allow repairs or maintenance operations to be carried out. The unit's components should be accessible and easy to disassemble without endangering people and objects.
- For this reason, when provisions of the installation manual are not complied with, the cost required to access and repair the units (in SAFETY CONDITIONS, as set out in prevailing regulations) with harnesses, ladders, scaffolding or any other elevation system will NOT be considered part of the warranty and will be charged to the end customer.
- The outdoor unit shall be installed in an open space that is always ventilated.
- The local gas regulations shall be observed.
- To handle, purge, and dispose the refrigerant, or break into the refrigerant circuit, the worker should have a certificate from an industry-accredited authority.
- While in installation or relocation of the product, do not mix the refrigerant with other gases including air or unspecified refrigerant. Failure to do so may cause pressure increase to result in rupture or injury.
- Do not cut or burn the refrigerant container or pipings.
- Use clean parts such as manifold gauge, vacuum pump, and charging hose for the refrigerant.
- Installation must be carried out by qualified personnel for handling the refrigerant. Additionally, reference the regulations and laws.
- Be careful not to let foreign substances (lubricating oil, refrigerant, water, etc.) enter the pipings.
- When mechanical ventilation is required, ventilation openings shall be kept clear of obstruction.
- For disposal of the product, follow the local laws and regulations.
- Do not work in a confined place.
- The work area shall be blocked.
- The refrigerant pipings shall be installed in the position where there are no substances that may result in corrosion.
- The following checks shall be performed for installation:
 - The charging amount depends on the room size.
 - The ventilation devices and outlets are operating normally and are not obstructed.
 - Markings and signs on the equipment shall be visible and legible.
- Upon leakage of the refrigerant, ventilate the room. When the leaked refrigerant is exposed to flame, it may cause generation of toxic gases.

Safety Information

- Make sure that the work area is safe from flammable substances.
- To purge air in the refrigerant, be sure to use a vacuum pump.
- Note that the refrigerant has no odour.
- The units are not explosion proof so they must be installed with no risk of explosion.
- This product contains fluorinated gases that contribute to global greenhouse effect. Accordingly, do not vent gases into the atmosphere.
- For installation with handling the refrigerant(R-32), use dedicated tools and piping materials. Working pressure of R-32 is higher than R410A, So failure to use the dedicated tools and piping materials may cause rupture or injury. Furthermore, it may cause serious accidents such as water leakage, electric shock or fire.
- Servicing shall be performed as recommended by the manufacturer. In case other skilled persons are joined for servicing, it shall be carried out under supervision of the person who is competent in handling flammable refrigerants.
- For servicing the units containing flammable refrigerants, safety checks are required to minimise the risk of ignition.
- Servicing shall be performed following the controlled procedure to minimize the risk of flammable refrigerant or gases.
- Do not install where there is a risk of combustible gas leakage.
- Do not place heat sources.
- Be cautious not to generate a spark as follows:
 - Do not remove the fuses with power on.
 - Do not disconnect the power plug from the wall outlet with power on.
 - It is recommended to locate the outlet in a high position. Place the cords so that they are not tangled.
- If the indoor unit is not R-32 compatible, an error signal appears and the unit will not operate.
- After installation, check for leakage. Toxic gas may be generated and if it comes into contact with an ignition source such as fan heater, stove, and cooker, cylinders, make sure that only the refrigerant recovery cylinders are used.

- Never directly touch any accidental leaking refrigerant. It could result in severe wounds caused by frostbite.

Power supply line, fuse or circuit breaker

WARNING

- Always make sure that the power supply is compliant with current safety standards. Always install the air conditioner in compliance with current local safety standards.
- Always verify that a suitable earthing connection is available.
- Verify that the voltage and frequency of the power supply comply with the specifications and that the installed power is sufficient to ensure the operation of any other domestic appliance connected to the same electric lines.
- Always verify that the cut-off and protection switches are suitably dimensioned.
- Verify that the air conditioner is connected to the power supply in accordance with the instructions provided in the wiring diagram included in the manual.
- Always verify that electric connections (cable entry, section of leads, protections..) are compliant with the electric specifications and with the instructions provided in the wiring scheme. Always verify that all connections comply with the standards applicable to the installation of air conditioners.
- Devices disconnected from the power supply should be completely disconnected in the condition of overvoltage category.
- Be sure not to perform power cable modification, extension wiring, and multiple wire connection.
 - It may cause electric shock or fire due to poor connection, poor insulation, or current limit override.
 - When extension wiring is required due to power line damage, refer to **Step 4 Optional: Extending the power cable** in the installation manual.

Installation Procedure

Step 1 Choosing the installation location

WARNING

- Because your air conditioner contains R-32 refrigerant, make sure that it is installed, operated, and stored in a room whose floor area is larger than the minimum required floor area specified in the following table:

Minimum required room area (A, m ²)			
m (kg)	Ceiling-mounted type	Wall-mounted type	Floor-standing type
≤ 1.842	No requirement		
1.843	3.64	4.45	28.9
1.9	3.75	4.58	30.7
2.0	3.95	4.83	34.0
2.2	4.34	5.31	41.2
2.4	4.74	5.79	49.0
2.6	5.13	6.39	57.5
2.8	5.53	7.41	66.7
3.0	5.92	8.51	76.6
3.2	6.48	9.68	87.2
3.4	7.32	10.9	98.4
3.6	8.20	12.3	110
3.8	9.14	13.7	123
4.0	10.1	15.1	136
4.2	11.2	16.7	150
4.4	12.3	18.3	165
4.6	13.4	20.0	180
4.8	14.6	21.8	196
5.0	15.8	23.6	213
5.2	17.1	25.6	230

- m : Total refrigerant charge in the system
- A : Minimum required room area

- IMPORTANT: it's mandatory to consider either the table 1 or taking into consideration the local law regarding the minimum living space of the premises.
- Minimum installation height of indoor unit is 0.6 m for floor mounted, 1.8 m for wall, 2.2 m for ceiling.

Installation location requirements

- Do not place the outdoor unit on its side or upside down. Failing to do so may cause the compressor lubrication oil to run into the cooling circuit and lead to a serious damage to the unit.
- Install the unit in a well-ventilated location away from direct sunlight or strong winds.
- Install the unit in a location that would not obstruct any passageways or thoroughfares.
- Install the unit in a location that would not inconvenience or disturb your neighbors, as they could be affected by the noise or the airflow coming from the unit.
- Install the unit in a location where the pipes and the cables can be easily connected to the indoor unit.
- Install the unit on a flat, stable surface that can withstand the weight of the unit. Otherwise, the unit can generate noise and vibration during operation.
- Install the unit so that the air flow is directed towards the open area.
- Maintain sufficient clearance around the outdoor unit, especially from a radio, computer, stereo system, etc.

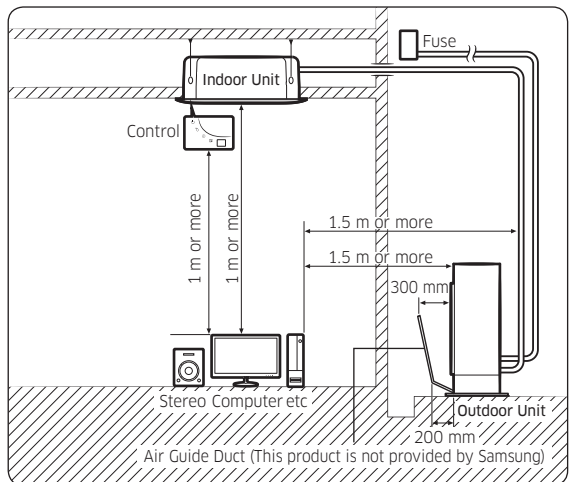

- Install the unit at a height where its base can be firmly fixed in place.
- Make sure that the water dripping from the drain hose runs away correctly and safely.

Installation Procedure

⚠ CAUTION

- You have just purchased a system air conditioner and it has been installed by your installation specialist.
- This device must be installed according to the national electrical rules.
- If your outdoor unit exceeds a net weight of 60 kg, do not install it on a suspended wall, but stand it on a floor.
- When installing the outdoor unit at the seaside, make sure that it is not directly exposed to sea breeze. If you cannot find an adequate place free from direct sea breeze, construct a protection wall or a protective fence.
 - Install the outdoor unit in a place (such as near buildings etc.) where it can be prevented from sea breeze. Failure to do so may cause a damage to the outdoor unit.

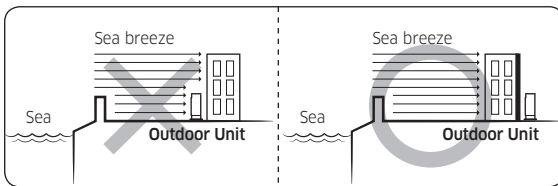

- If you cannot avoid installing the outdoor unit at the seaside, construct a protection wall around to block the sea breeze.
- Construct a protection wall with a solid material such as concrete to block the sea breeze. Make sure that the height and the width of the wall are 1.5 times larger than the size of the outdoor unit. Also, secure a space larger than 700 mm between the protection wall and the outdoor unit for exhausted air to ventilate.

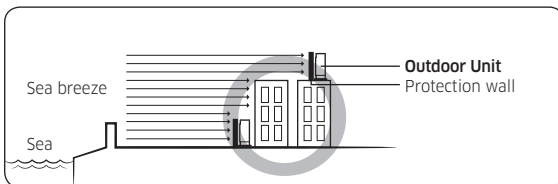

⚠ CAUTION

- Depending on the condition of power supply, unstable power or voltage may cause malfunction of the parts or control system. (At the ship or places using power supply from electric generator...etc)
- Install the unit in a place where water can drain smoothly.
- If you have any difficulty finding installation location as prescribed above, contact your manufacturer for details.
- Be sure to clean the sea water and the dust on the heat exchanger of the outdoor unit and apply a corrosion inhibitor on it. (At least once in a year.)

Outdoor unit dimensions

(Unit: mm)

A Type	
AC100RXADKG/AC100RXADNG/AC120RXADKG/AC120RXADNG	
B Type	
AC140RXADKG/AC140RXADNG	

Minimum clearances for the outdoor unit

When installing 1 outdoor unit

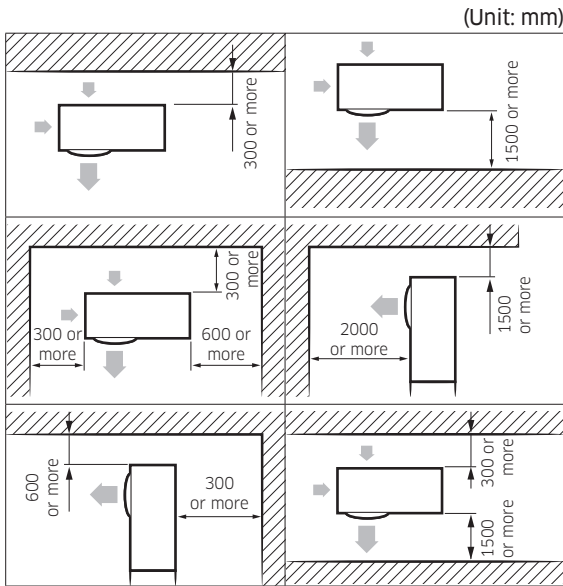

When installing more than 1 outdoor unit

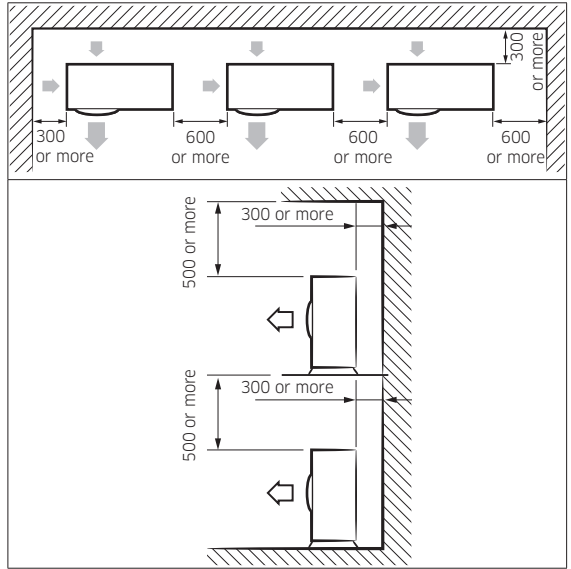
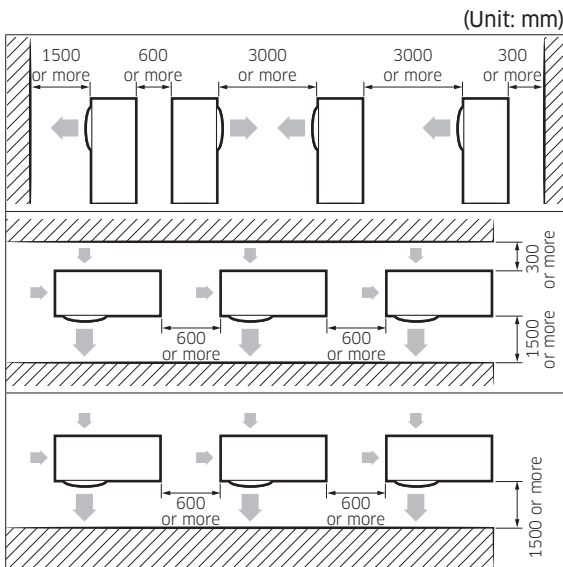

! CAUTION

- The outdoor unit must be installed according to the specified distances in order to permit accessibility from each side, to guarantee correct operation, maintenance, and repair of the unit. The components of the outdoor unit must be reachable and removable under safe conditions for people and the unit.

! WARNING

- Should adopt bar type louver. Don't use a type of rain resistance louver.

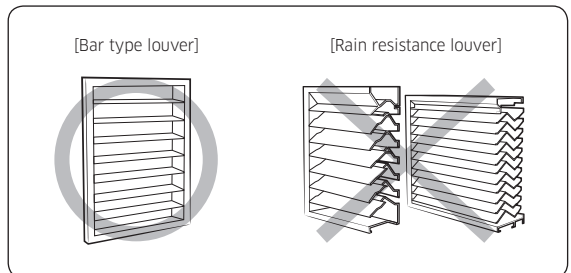

- Louver specifications.
 - Angle criteria : less than 20°
 - Opening ratio criteria : greater than 80%

Installation Procedure

Moving the outdoor unit with wire rope

- 1 Before carrying the outdoor unit, fasten two wire ropes of 8 m or longer, as shown in the figure.
- 2 To prevent damages or scratches effectively, insert a piece of cloth between the outdoor unit and the ropes.
- 3 Move the outdoor unit.

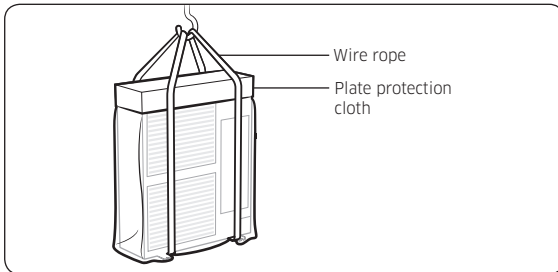

⚠ CAUTION

- Install a drain outlet at the lowest end around the base for outdoor unit drainage
- When installing the outdoor unit on the roof, waterproof the unit and check the ceiling strength.

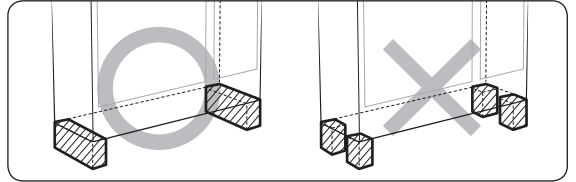

- Make sure that the wall can support the weights of the rack and the outdoor unit.
- Install the rack close to the column as much as possible.

Step 2 Fixing the outdoor unit in place

Install the outdoor unit on a rigid and stable base to prevent disturbance from any noise caused by vibration. When installing the unit at a height or in a location exposed to strong winds, fix the unit securely to a support (i.e., a wall or a ground).

Fix the outdoor unit with anchor bolts. Make sure that the anchor bolts are 20 mm or higher from the base surface.

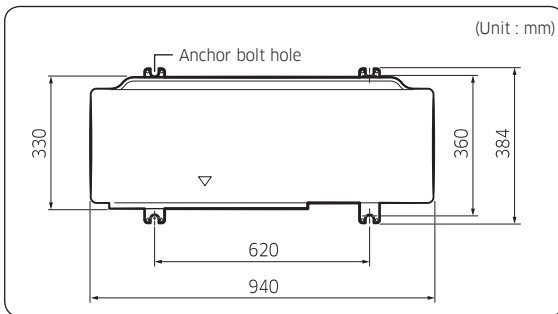

Optional: Fixing the outdoor unit to a wall with a rack

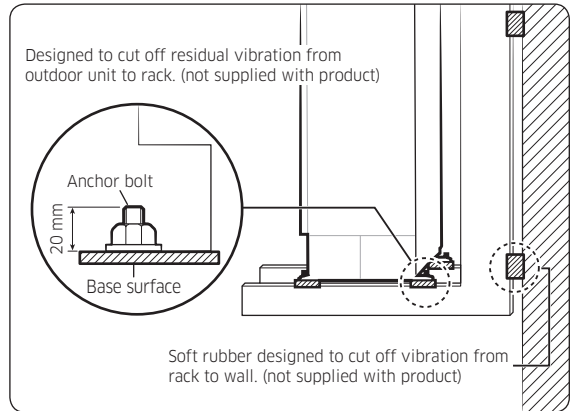

- Install a proper grommet in order to reduce noise and residual vibration transferred by the outdoor unit towards the wall.

⚠ CAUTION

- When installing an air guide duct, be sure to check the following:
 - The screws do not damage the copper pipe.
 - The air guide duct is fixed firmly on the guard fan.

Step 3 Connecting the power cables, communication cable, and controllers

You must connect the following three electrical cables to the outdoor unit:

- The main power cable between the auxiliary circuit breaker and the outdoor unit.
- The outdoor-to-indoor power cable between the outdoor unit and the indoor unit.
- The communication cable between the outdoor unit and the indoor unit.

CAUTION

- During installation, make first the refrigerant connections and then the electrical connections. If the unit is uninstalled, first disconnect the electrical cables and then the refrigerant connections.
- Connect the air conditioner to the earthing system before making the electrical connections.

NOTE

- Especially, if your outdoor unit is the one designed for Russian and European markets, consult the supply authority, if necessary, to estimate and reduce the supply system impedance before installation.

Air conditioning system examples

When using earth leakage circuit breaker (ELCB) for a single phase

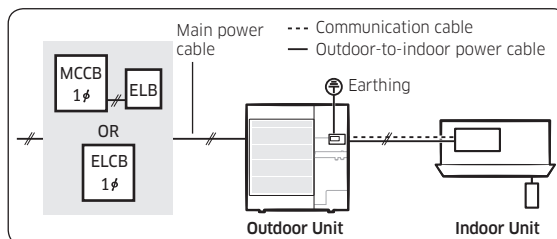

When using earth leakage circuit breaker (ELCB) for a 3-phase, 4-wire system (3P4W)

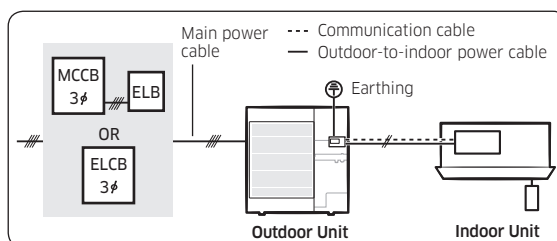

CAUTION

- If the outdoor unit is installed in a location vulnerable to an electric leak or submergence, make sure to install an ELCB.
- For the product that uses the R-32 refrigerant, be cautious not to generate a spark by keeping the following requirements:
 - Do not remove the fuses with power on.
 - Do not disconnect the power plug from the wall outlet with power on.
 - It is recommended to locate the outlet in a high position. Place the cords so that they are not tangled.

Installation Procedure

Connecting the main power cable

When using ELB for 1 phase and 3 phase

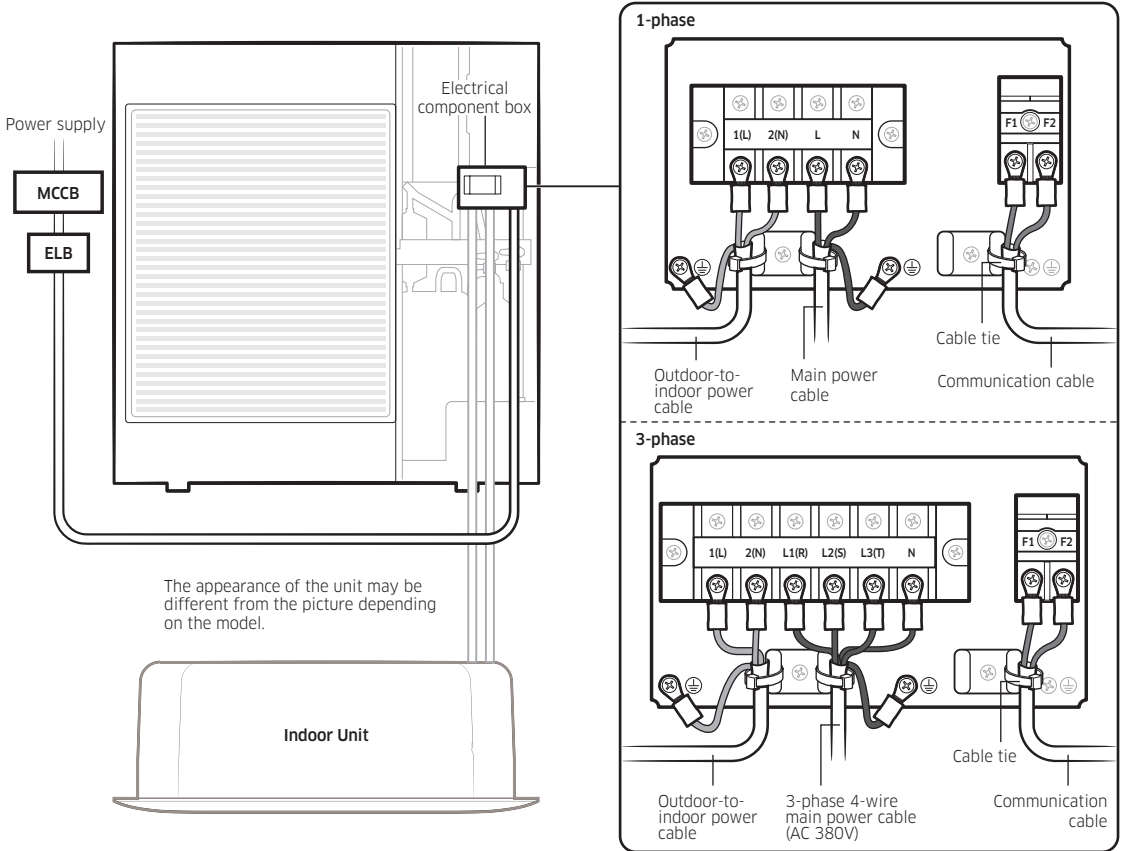

⚠ CAUTION

- You should connect the power cable into the power cable terminal and fasten it with a clamp.
- The unbalanced power must be maintained within 2% of supply rating.
If the power is unbalanced greatly, it may shorten the life of the condenser. If the unbalanced power is exceeded over 4% of supply rating, the indoor unit is protected, stopped and the error mode indicates.
- To protect the product from water and possible shock, you should keep the power cable and the connection cord of the indoor and outdoor units within ducts. (with appropriate IP rating and material selection for your application)
- Ensure that main supply connection is made through a switch that disconnects all poles, with contact gap of a least 3 mm.
- Devices disconnected from the power supply should be completely disconnected in the condition of overvoltage category.
- Keep distances of 50 mm or more between power cable and communication cable.

Main power terminal block specifications

- 1-phase terminal block specifications

(Unit: mm)

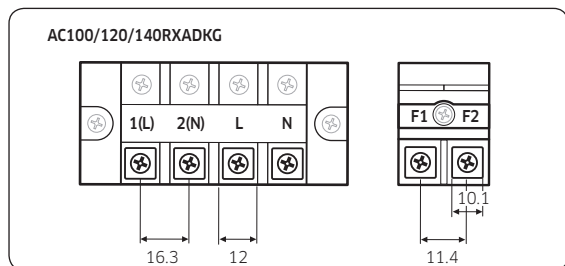

- 3-phase terminal block specifications

(Unit: mm)

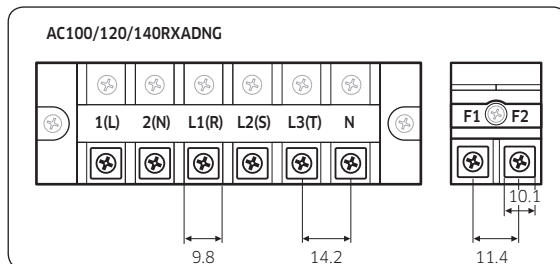

Main power cable specifications

The power cable is not supplied with air conditioner.

- Select the power supply cable in accordance with relevant local and national regulations.
- Wire size must comply with the applicable local and national code.
- Specifications for local wiring power cord and branch wiring are in compliance with local cord.

Single phase

Model		Outdoor unit				Input current (A)				Power supply	
Indoor unit	Outdoor unit	Hz	Voltage range (V)			Outdoor unit		Indoor unit	Total	MCA (A)	MFA (A)
			Rated	Min.	Max.	Cooling	Heating				
AC100RN4DKG	AC100RXADKG	50	220 to 240	198	264	24.0	24.0	1.0	25.0	25.0	30.0
AC100RN4PKG								1.5	25.5	25.5	30.0
AC100RNMDKG								2.5	26.5	26.5	30.0
AC100RNCDKG								2.5	26.5	26.5	30.0
AC100RNTDKG								1.6	25.6	25.6	30.0
AC120RN4DKG	AC120RXADKG					1.0	25.0	25.0	30.0		
AC120RN4PKG						1.5	25.5	25.5	30.0		
AC120RNMDKG						2.5	26.5	26.5	30.0		
AC120RNCDKG						2.5	26.5	26.5	30.0		
AC140RN4DKG	AC140RXADKG					1.0	33.0	33.0	40.0		
AC140RN4PKG		1.5	33.5	33.5	40.0						
AC140RNMDKG		2.5	34.5	34.5	40.0						
AC140RNCDKG		2.5	34.5	34.5	40.0						

Installation Procedure

3-phase

Model		Outdoor unit				Input current (A)				Power supply	
Indoor unit	Outdoor unit	Hz	Voltage range (V)			Outdoor unit		Indoor unit	Total	MCA (A)	MFA (A)
			Rated	Min.	Max.	Cooling	Heating				
AC100RN4DKG	AC100RXADNG	50	380 to 415	342	456.5	16.1	16.1	1.0	17.1	17.1	17.1
AC100RN4PKG								1.5	17.6	17.6	17.6
AC100RNMDKG								2.5	18.6	18.6	18.6
AC100RNCDKG								2.5	18.6	18.6	18.6
AC100RNTDKG								1.6	17.7	17.7	17.7
AC120RN4DKG	AC120RXADNG							1.0	17.1	17.1	17.1
AC120RN4PKG								1.5	17.6	17.6	17.6
AC120RNMDKG								2.5	18.6	18.6	18.6
AC120RNCDKG								2.5	18.6	18.6	18.6
AC140RN4DKG	AC140RXADNG							1.0	17.1	17.1	17.1
AC140RN4PKG								1.5	17.6	17.6	17.6
AC140RNMDKG								2.5	18.6	18.6	18.6
AC140RNCDKG								2.5	18.6	18.6	18.6

NOTE

- Voltage range
 - Units are suitable for use on electrical systems where voltage supplied to unit terminal is not below or above listed range limits.
- Maximum allowable voltage variation between phases is 2%.
- Wire size & type must comply with the applicable local and national code.
 - Wire size: Based on the value of MCA.
 - Wire type: 60245 IEC57(IEC) or H05RN-F(CENELEC) grade or more.
- MFA is used to select the circuit breaker and the ground fault circuit interrupter (earth leakage circuit breaker).
- MCA represents maximum input current.
 - MFA represents capacity which may accept MCA
 - Abbreviations
MCA: Min. Circuit Amps. (A)
MFA: Max. Fuse Amps. (A)

- This equipment complies with IEC 61000-3-12 provided that the short-circuit power S_{sc} is greater than or equal to $S_{sc} (*2)$ at the interface point between the user's supply and the public system. It is the responsibility of the installer or user of the equipment to ensure, by consultation with the distribution network operator if necessary, that the equipment is connected only to a supply with a short-circuit power S_{sc} greater than or equal to $S_{sc}(*2)$.

Model	S_{sc} [MVA]
AC100RXADKG	1.4
AC100RXADNG	2.5
AC120RXADKG	1.9
AC120RXADNG	2.7
AC140RXADKG	1.9
AC140RXADNG	2.5

Silence mode controller wiring diagram

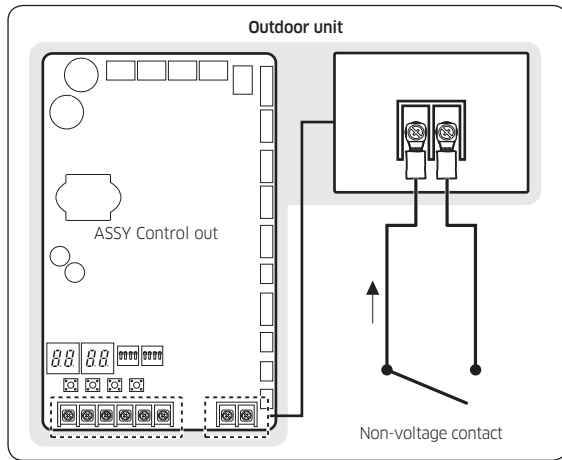

3-phase

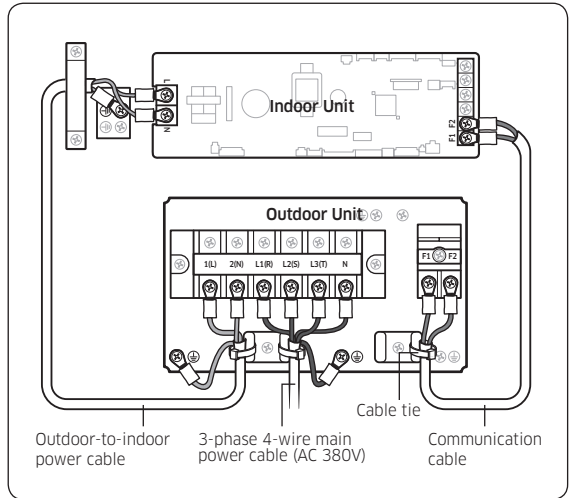

Connecting the outdoor-to-indoor power cable and the communication cable

1-phase

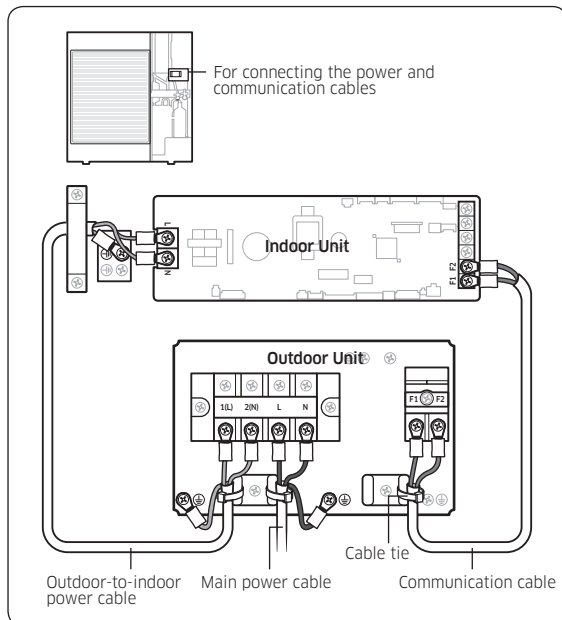

NOTE

- Lay the electrical wiring so that the front cover does not rise up when doing wiring work and attach the front cover securely.
- Ground wire for the indoor unit and outdoor unit connection cable must be clamped to a soft copper tin-plated eyelet terminal with M4 screw hole (NOT SUPPLIED WITH UNIT ACCESSORIES).

Installation Procedure

Outdoor-to-indoor power terminal specifications

- Connect the cables to the terminal board using the compressed ring terminal.
- Cover a solderless ring terminal and a connector part of the power cable and then connect it.

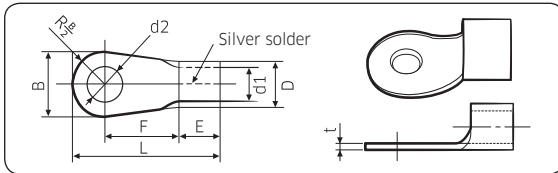

Nominal dimensions for cable (mm ²)	Nominal dimensions for screw (mm)	B		D		d1		E (mm)	F (mm)	L (mm)	d2		t (mm)
		Standard dimension (mm)	Allowance (mm)	Standard dimension (mm)	Allowance (mm)	Standard dimension (mm)	Allowance (mm)				Standard dimension (mm)	Allowance (mm)	
4/6	4	9.5	±0.2	5.6	+0.3 -0.2	3.4	±0.2	6	5	20	4.3	+0.2 0	0.9
	8	15							9	28.5	8.4	+0.4 0	
10	8	15	±0.2	7.1	+0.3 -0.2	4.5	±0.2	7.9	9	30	8.4	+0.4 0	1.15
16	8	16	±0.2	9	+0.3 -0.2	5.8	±0.2	9.5	13	33	8.4	+0.4 0	1.45
25	8	12	±0.3	11.5	+0.5 -0.2	7.7	±0.2	11	15	34	8.4	+0.4 0	1.7
	8	16.5							13		8.4		
35	8	16	±0.3	13.3	+0.5 -0.2	9.4	±0.2	12.5	13	38	8.4	+0.4 0	1.8
	8	22							13		43		
50	8	22	±0.3	13.5	+0.5 -0.2	11.4	±0.3	17.5	14	50	8.4	+0.4 0	1.8
70	8	24	±0.4	17.5	+0.5 -0.4	13.3	±0.4	18.5	20	51	8.4	+0.4 0	2.0

- Connect the rated cables only.
- Connect using a driver which is able to apply the rated torque to the screws.
- If the terminal is loose, fire may occur caused by arc. If the terminal is connected too firmly, the terminal may be damaged.

Tightening torque (N·m)	
M4	0.8 to 1.2
M5	2.0 to 3.0

- 1 N·m = 10 kgf·cm

CAUTION

- When connecting cables, you can connect the cables to the electrical part or connect them through the holes below depending on the spot.
- Connect the communication cable between the indoor and outdoor units through a conduit to protect against external forces, and feed the conduit through the wall together with refrigerant piping.
- Remove all burrs at the edge of the knock-out hole and secure the cable to the outdoor knock-out using lining and bushing with an electrical insulation such as rubber and so on.
- Must keep the cable in a protection tube.
- Keep distances of 50mm or more between power cable and communication cable.
- When the cables are connected through the hole, remove the Plate bottom.

Outdoor-to-indoor power and communication cables specifications

Indoor power supply		
Power supply	Max/Min (V)	Indoor power cable
1 ϕ , 220-240V, 50 Hz	$\pm 10\%$	1.5 mm ² ↑, 3 wires
Communication cable		
0.75 to 1.5 mm ² , 2 wires		

- Power supply cords of parts of appliances for outdoor use shall not be lighter than polychloroprene sheathed flexible cord. (Code designation IEC:60245 IEC 57 / CENELEC: H05RN-F or IEC:60245 IEC 66 / CENELEC: H07RN-F)
- When installing the indoor unit in a computer room or net work room, use the double shielded (tape aluminium / polyester braid + copper) cable of FROHH2R type.

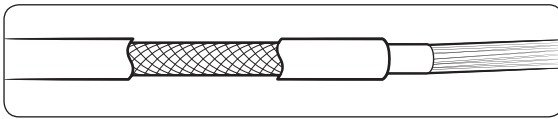

Step 4 Optional: Extending the power cable

1 Prepare the following tools.

Tools	Spec	Shape
Crimping pliers	MH-14	
Connection sleeve (mm)	20x ϕ 6.5 (HxOD)	
Insulation tape	Width 19 mm	
Contraction tube (mm)	70x ϕ 8.0 (LxOD)	

2 As shown in the figure, peel off the shields from the rubber and wire of the power cable.

- Peel off 20 mm of cable shields from the pre-installed tube.

CAUTION

- For information about the power cable specifications for indoor and outdoor units, refer to the installation manual.
- After peeling off cable wires from the pre-installed tube, insert a contraction tube.

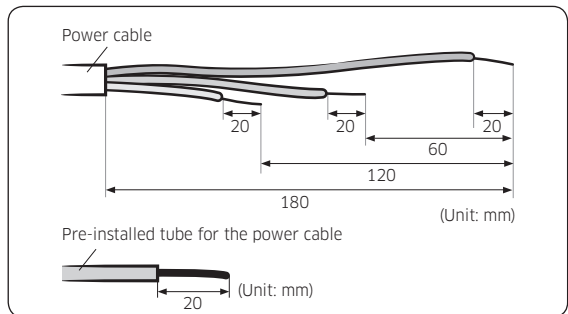

Installation Procedure

3 Insert both sides of core wire of the power cable into the connection sleeve.

- **Method 1:** Push the core wire into the sleeve from both sides.
- **Method 2:** Twist the wire cores together and push it into the sleeve.

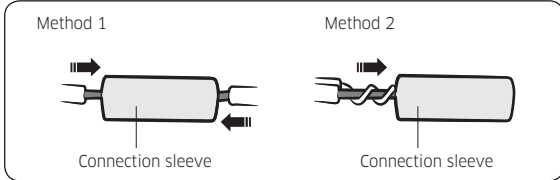

4 Using a crimping tool, compress the two points and flip it over and compress another two points in the same location.

- The compression dimension should be 8.0.

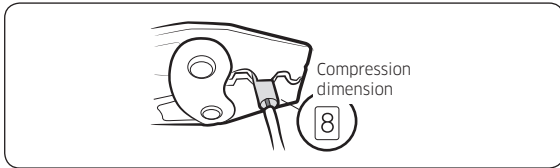

- After compressing it, pull both sides of the wire to make sure it is firmly pressed.

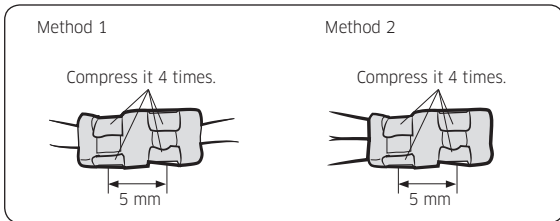

5 Wrap it with the insulation tape twice or more and position your contraction tube in the middle of the insulation tape.

Three or more layers of insulation are required.

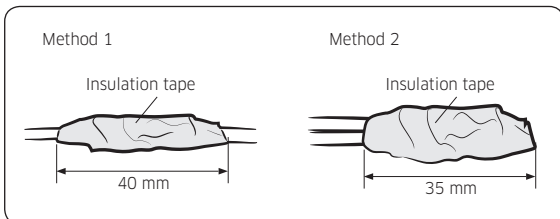

6 Apply heat to the contraction tube to contract it.

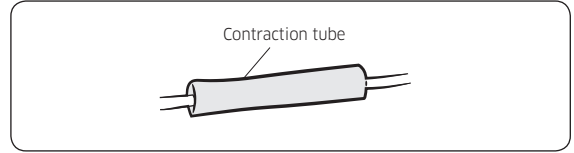

7 After tube contraction work is completed, wrap it with the insulation tape to finish.

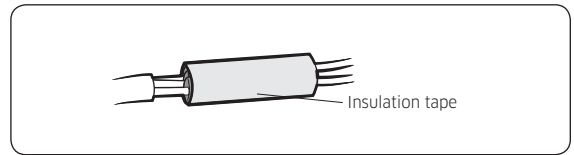

CAUTION

- Make sure that the connection parts are not exposed to outside.
- Be sure to use insulation tape and a contraction tube made of approved reinforced insulating materials that have the same level of withstand voltage with the power cable. (Comply with the local regulations on extensions.)

WARNING

- In case of extending the electric wire, please DO NOT use a round-shaped Pressing socket.
 - Incomplete wire connections can cause electric shock or a fire.

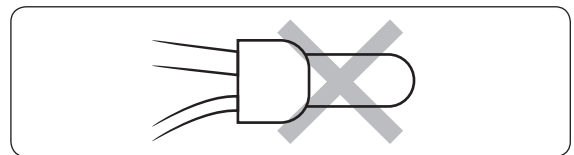

Step 5 Connecting the refrigerant pipe

Items	Maximum allowable length			
	Single Installation		DPM Installation	
Applicable outdoor unit models	AC100RXAD*G AC120RXAD*G	AC140RXAD*G	AC100RXAD*G AC120RXAD*G	AC140RXAD*G
Total pipe length (L1+...+Ln+1+a+b)	-	-	50 m	75 m
Main pipe (L1)	50 m	75 m	30 m	50 m
Max. distance among indoor units (D)	-	-	10 m	10 m
Max. length after branch	-	-	15 m	15 m
Max. height difference between outdoor and indoor units (h1)	30 m	30 m	30 m	30 m
Max. height difference among indoor units(h2)	-	-	0.5 m	0.5 m
Max Pipe length difference among indoor units after branch [L2-L3 or L2-L4 or L2-L5 or a-b or (a+L2)-(b+L4) or (a+L3)-(b+L5)]	-	-	5 m	5 m

- "n" means the number of indoor unit connection of DPM.

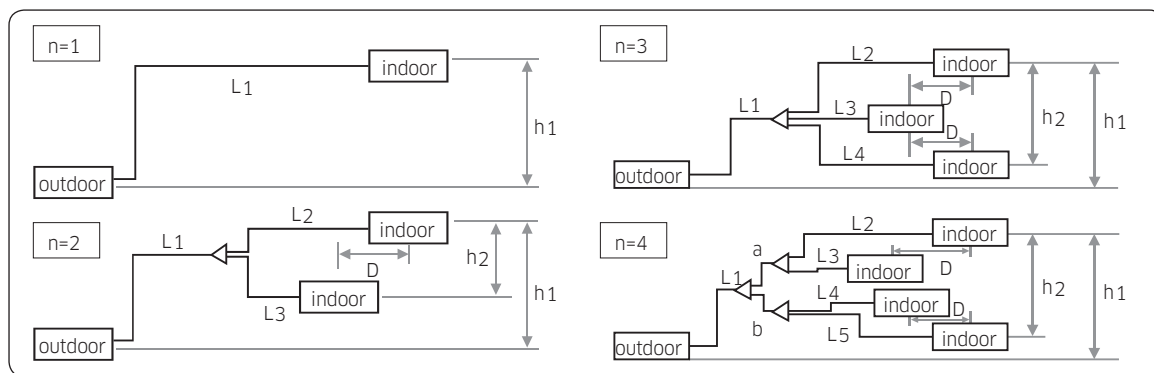

- Use a joint kit that is only for DPM.
- Temper grade and minimum thickness of the refrigerant pipe

Outer diameter [mm]	Minimum thickness [mm]	Temper grade
ø6.35	0.7	C1220T-O
ø9.52	0.7	
ø12.70	0.8	
ø15.88	1.0	
ø15.88	0.8	C1220T-1/2H OR C1220T-H
ø19.05	0.9	
ø22.23	0.9	

Installation Procedure

⚠ CAUTION

- Be sure to use C1220T-1/2H (Semi-hard) pipe for more than $\varnothing 19.05$ mm. If you use C1220T-O (Soft) pipe for $\varnothing 19.05$ mm, the pipe may be broken, which can result in an injury.

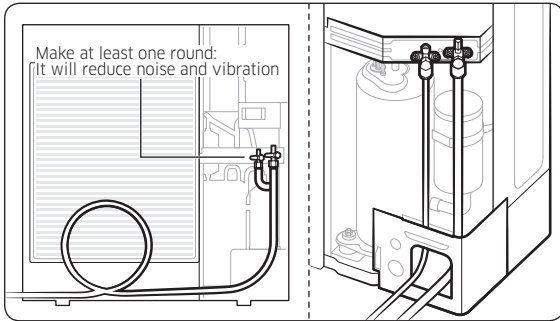

- The appearance of the unit may be different from the diagram depending on the model.

⚠ CAUTION

- After connecting the pipes with knock-out treatment, plug the space around the pipes.
- After connecting the pipes, proceed exactly as directed in the guide to prevent interference with the internal parts.
- Tighten the nuts to the specified torques. If overtightened, the nuts could be broken so refrigerant may leak.
- Protect or enclose refrigerant tubing to avoid mechanical damage.

Step 6 Optional: Cutting and flaring the pipes

- 1 Make sure that you have the required tools available. (pipe cutter, reamer, flaring tool, and pipe holder)
- 2 If you wish to shorten the pipes, cut it with a pipe cutter, taking care to ensure that the cut edge remains at a 90° angle with the side of the pipe. Refer to the illustrations below for examples of edges cut correctly and incorrectly.

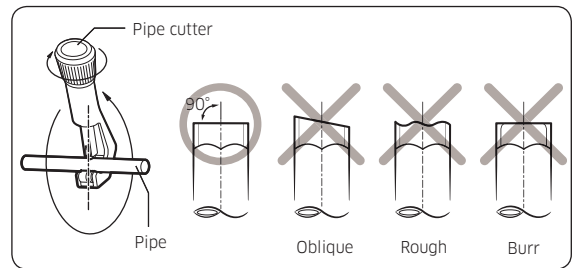

- 3 To prevent any gas from leaking out, remove all burrs at the cut edge of the pipe, using a reamer.
- 4 Slide a flare nut on to the pipe and modify the flare.

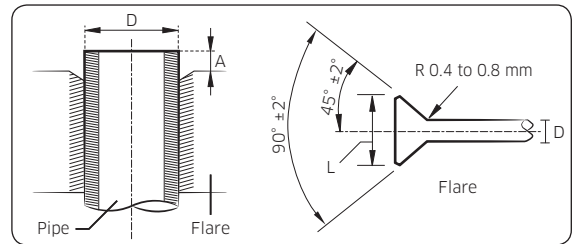

Outer diameter (D)	Depth (A)	Flare dimension (L)
$\varnothing 6.35$ mm	1.3mm	8.7 to 9.1 mm
$\varnothing 9.52$ mm	1.8mm	12.8 to 13.2 mm
$\varnothing 12.70$ mm	2.0mm	16.2 to 16.6 mm
$\varnothing 15.88$ mm	2.2mm	19.3 to 19.7 mm
$\varnothing 19.05$ mm	2.2mm	23.6 to 24.0 mm

5 Check that the flaring is correct, referring to the illustrations below for examples of incorrect flaring.

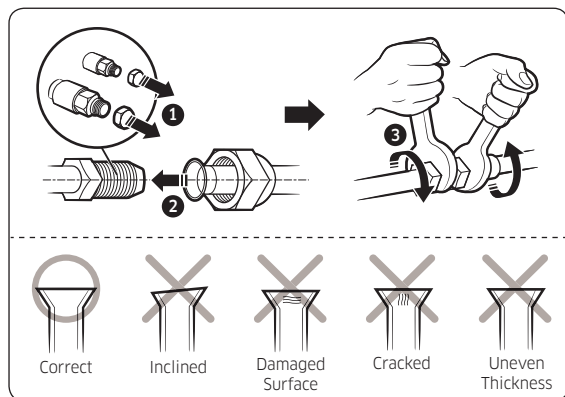

CAUTION

- Keep the piping length at a minimum to minimize the additional refrigerant charge due to piping extension.
- When connecting the pipes, make sure that surrounding objects do not interfere with or contact them to prevent refrigerant leakage due to physical damage.
- Make sure that the spaces where the refrigerant pipes are installed comply with national gas regulations.
- Be sure to perform works such as additional refrigerant charging and pipe welding under the conditions of good ventilation.
- Be sure to perform welding and piping works for mechanical connections under the conditions that the refrigerant does not circulate.
- When reconnecting the pipes, make sure to perform flared-jointing newly to prevent refrigerant leakage.
- When working on the refrigerant pipes and the flexible refrigerant connectors, be careful that they are not damaged physically by surrounding objects.
- For installation with handling the R-32 refrigerant, use the special tools for the R32 refrigerant (manifold gauge, vacuum pump, charging hose, etc.).
- During tests never pressurize the appliances with a pressure higher than the maximum allowable pressure(as indicated on the nameplate of the unit).
- Never directly touch any accidental leaking refrigerant. This could result in severe wounds caused by frostbite.

- Never install a dryer to this unit in order to guarantee its lifetime.
- If the pipes require brazing ensure that OFN(Oxygen Free Nitrogen) is flowing through the system.
- Nitrogen blowing pressure range is 0.02 to 0.05 MPa.
- If you need a pipe longer than specified in piping codes and standards, you must add refrigerant to the pipe. Otherwise, the indoor unit may freeze.
- While removing burrs, put the pipe face down to make sure that the burrs do not get in to the pipe.

Step 7 Installing oil traps

Check the following list and install an oil trap.

- Based on cooling operation, install it on the gas side pipe only.
- Install the oil trap only in between the outdoor unit and the first branch joint and it should be installed at every 10 m.
- Radius of curvature (R) on the oil trap are as follows;

Pipe diameter (D, mm)	12.70	15.88	19.05	22.23	25.40	28.60	31.75
Radius of curvature (R, mm)	25 and over	32 and over	38 and over	41 and over	51 and over	57 and over	60 and over

- Height of the oil trap (H): $4R \leq H \leq 6R$
- When the indoor unit is installed at a higher place than the outdoor unit

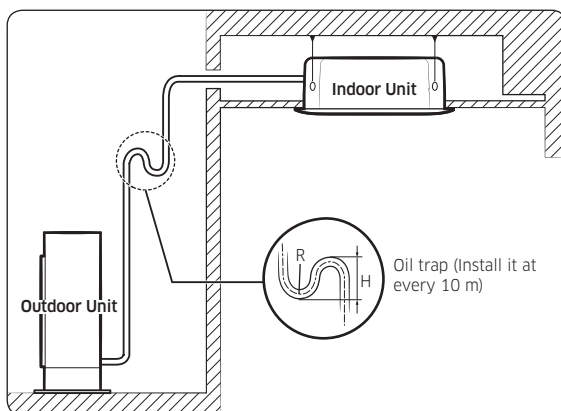

Installation Procedure

Step 8 Connecting up and removing air in the circuit

⚠ CAUTION

- When installing, make sure there is no leakage. When recovering the refrigerant, ground the compressor first before removing the connection pipe. If the refrigerant pipe is not properly connected and the compressor works with the service valve open, the pipe inhales the air and it makes the pressure inside of the refrigerant cycle abnormally high. It may cause explosion and injury.

The air in the indoor unit and in the pipe must be evacuated. If air remains in the refrigerant pipes, it will affect the compressor either reduce cooling/heating capacity or lead to a malfunction. Refrigerant for air purging is not charged in the outdoor unit. Use Vacuum Pump as shown at the right figure.

- 1 Connect each assembly pipe to the appropriate valve on the outdoor unit and tighten the flare nut.
- 2 Referring to the illustration below, tighten the flare nut on section D first manually and then with a torque wrench, applying the following torque.

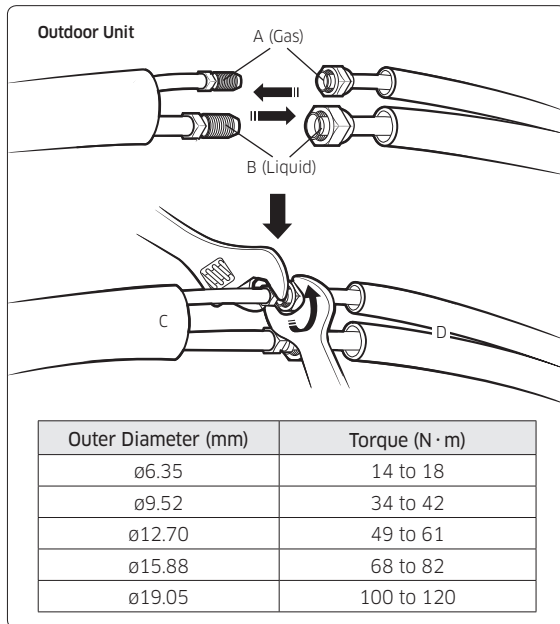

- 3 Connect the charging hose of low pressure side of manifold gauge to the packed valve having a service port as shown at the figure.

⚠ CAUTION

- The designs and shape are subject to change according to the model.

- 4 Open the valve of the low pressure side(A) of manifold gauge anticlockwise.

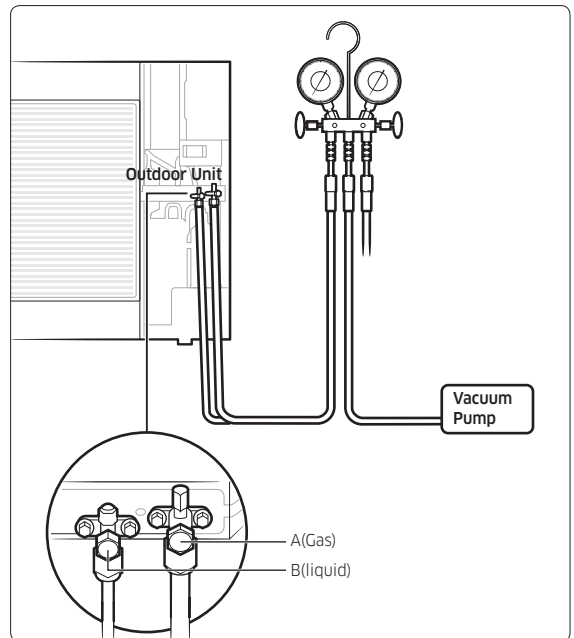

- 5 Purge the air from the system using vacuum pump for about 10 minutes.
 - Close the valve of the low pressure side of manifold gauge clockwise.
 - Make sure that pressure gauge shows -0.1 MPa (-76 cmHg) after about 10 minutes. This procedure is very important to avoid a gas leak.
 - Turn off the vacuum pump.
 - Remove the hose of the low pressure side of manifold gauge.
- 6 Open the stop valve of both liquid and gas sides.
- 7 Mount the valve stem nuts and the service port cap to the valve, and tighten them at the torque of 18 N · m with a torque wrench.

8 Check for gas leakage.

- At this time, especially check for gas leakage from the 3-way valve's stem nuts(A port), and from the service port cap.

CAUTION

- Connect the indoor and outdoor units using pipes with flared connections (not supplied). For the lines, use insulated, unwelded, degreased and deoxidized copper pipe, (Cu DHP type to ISO 1337 or UNI EN 12735-1), suitable for operating pressures of at least 4200 kPa and for a burst pressure of at least 20700 kPa. Copper pipe for hydro-sanitary applications is completely unsuitable.
- For sizing and limits (height difference, line length, max. bends, refrigerant charge, etc.) see "Connecting refrigerant pipe section".

Step 9 Adding refrigerant (R-32)

Precautions on adding the R-32 refrigerant

In addition to the conventional charging procedure, the following requirements shall be kept.

- Make sure that contamination by other refrigerants does not occur for charging.
- To minimize the amount of refrigerant, keep the hoses and lines as short as possible.
- The cylinders shall be kept upright.
- Make sure that the refrigeration system is earthed before charging.
- Label the system after charging, if necessary.
- Extreme care is required not to overcharge the system.
- Before recharging, the pressure shall be checked with nitrogen blowing.
- After charging, check for leakage before commissioning.
- Be sure to check for leakage before leaving the work area.
- The outdoor unit is loaded with sufficient refrigerant for the standard piping. Thus, refrigerant must be added if the piping is lengthened. This operation can only be performed by a qualified refrigeration specialist. To determine the quantity of refrigerant charge, see **Calculating the quantity of refrigerant to add** on page 25.

1 Check if the stop valve is closed completely.

2 Charge the refrigerant through the service port of the liquid stop valve.

NOTE

- Do not charge the refrigerant through the service port of the gas stop valve.
- ## 3 If you have any difficulty charging the refrigerant as described in the steps above, take the following steps:
- Open the liquid stop valve and gas stop valve.
 - Operate the air conditioner by pressing the K2 key on the outdoor unit PCB.
 - After about 30 minutes, charge the refrigerant through the service port of the gas stop valve.

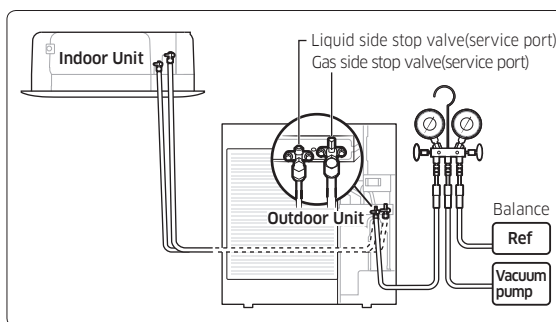

Important information: regulation regarding the refrigerant used

This product contains fluorinated greenhouse gases. Do not vent gases into the atmosphere.

CAUTION

- Inform user if the system contains 5 tCO₂e or more of fluorinated greenhouse gases. In this case, it must be checked for leakage at least once every 12 months, according to regulation No. 517/2014. This activity must be covered by qualified personnel only.
- In the case of the situation above, the installer (or authorized person with responsibility for final check) must provide a maintenance book, with all the information recorded, according to REGULATION (EU) No. 517/2014 OF THE EUROPEAN PARLIAMENT AND OF THE COUNCIL of 16 April 2014 on fluorinated greenhouse gases.

Installation Procedure

Please fill in the following with indelible ink on the refrigerant charge label supplied with this product and on this manual.

- ①: The factory refrigerant charge of the product.
- ②: The additional refrigerant amount charged in the field.
- ① + ②: The total refrigerant charge.

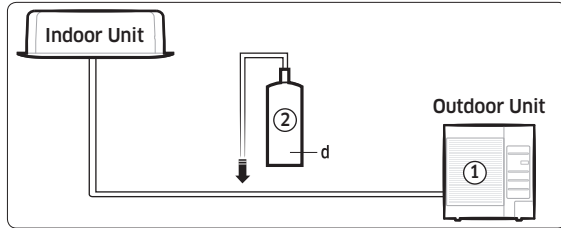

Unit	kg	tCO ₂ e
①, a		
②, b		
① + ②, c		

Refrigerant type	GWP value
R-32	675

- GWP: Global Warming Potential
- Calculating tCO₂e : kg x GWP / 1000

NOTE

- Factory refrigerant charge of the product: see unit name plate
- Additional refrigerant amount charged in the field (Refer to the above information for the quantity of refrigerant replenishment.)
- Total refrigerant charge
- Refrigerant cylinder and manifold for charging

CAUTION

- The filled-out label must be adhered in the proximity of the product charging port (e.g. onto the inside of the stop valve cover).
- Make sure that the total refrigerant charge does not exceed (A), the maximum refrigerant charge, which is calculated in the following formula: Maximum refrigerant charge (A) = factory refrigerant charge (B) + maximum additional refrigerant charge due to piping extension (C).

(Unit: g)

Model	A	B	C
AC100RXAD*G AC120RXAD*G	3700	2700	1000
AC140RXAD*G	5150	2900	2250

Charging the refrigerant under conditions of liquid by using a liquid pipe

It is necessary for recharging under conditions of liquid. When recharging refrigerant from the refrigerant cylinder to the equipment, follow the instructions below.

- Before recharging, check whether the cylinder has a siphon or not. There are two ways to recharge the refrigerant.

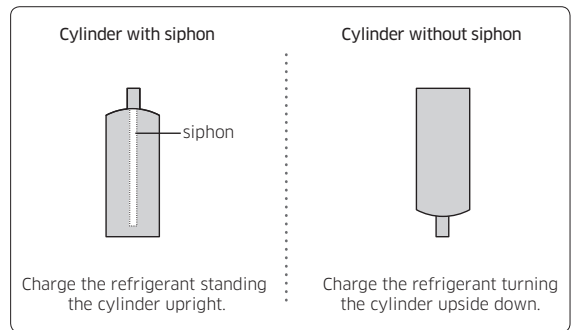

NOTE

- During the measuring operation of refrigerant quantity added use an electronic balance. If cylinder doesn't have syphon, upset it.

Calculating the quantity of refrigerant to add

The quantity of additional refrigerant is variable according to the installation situation. Thus, make sure the outdoor unit situation before adding refrigerant. This operation can only be performed by a qualified refrigeration specialist.

Single installation outdoor unit

Model	Interconnection pipe length (m)					
	0~30	30~40	40~50	50~60	60~70	70~75
AC100RXAD*G AC120RXAD*G	0	+50 g/m over 30 m		-	-	-
AC140RXAD*G	0	+50 g/m over 30 m				

DPM installation outdoor unit

Model	Diameter of L1, a & b pipe	Installation condition	Amount of additional refrigerant charging
AC100RXAD*G AC120RXAD*G	Ø9.52	$L_1 + \dots + L_{n-1} \leq 50 \text{ m}$	$(L_1+a+b-5) \times 40 \text{ [g]} + (L_2+\dots+L_{n-1}) \times 30 \text{ [g]}$ If $(L_1+a+b) < 5 \text{ m}$, $(L_2+\dots+L_{n-1}) \times 30 \text{ [g]}$
AC140RXAD*G	Ø9.52	$L_1 + \dots + L_{n-1} \leq 75 \text{ m}$	$(L_1+a+b-5) \times 40 \text{ [g]} + (L_2+\dots+L_{n-1}) \times 30 \text{ [g]}$ If $(L_1+a+b) < 5 \text{ m}$, $(L_2+\dots+L_{n-1}) \times 30 \text{ [g]}$

- “n” means the number of indoor unit connection of DPM.

Installing DPM

DPM allowable Outdoor and indoor unit models

DPM allowable Outdoor and indoor unit models			
Outdoor unit	2 IDUs connection	3 IDUs connection	4 IDUs connection
	Indoor Unit	Indoor Unit	Indoor Unit
AC100RXAD*G	AC052RN*DKG	AC035RN*DKG	-
AC120RXAD*G	-	AC052RN*DKG	AC035RN*DKG
AC140RXAD*G	AC071RN**KG	AC052RN*DKG	AC035RN*DKG

- Installation of multiple indoor units should consist of units that have the same capacity.
e.g. When you install the AC100RXADKG outdoor unit as DPM combination such as 2 or 3 indoor units connection, only the combination of two AC052RN*DKG or three AC035RN*DKG is available.

Space requirements for indoor and outdoor units and piping installation

(Refer to page 7~10 installation specification.)

- Two indoor units should be installed in one area which is not divided by a wall.
- The distance between two indoor units should be within a straight-line of 10m.
- After branching, the distance between the piping connected to the two indoor units should be within 5m.
- The height difference between two units should be within 0.5m.
- Use the joint KIT that is only for DPM. (Please refer to the table below)

DPM KIT	2-Indoor units connection	3-Indoor units connection	4-Indoor units connection
	MXJ-2D2509K	MXJ-3D2509K	MXJ-4D2509K

Installation Procedure

Connecting communication line and wired remote controller

- In case of 2 indoor units connection

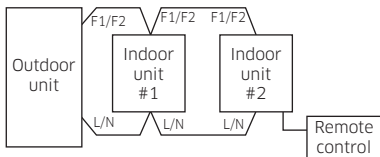

- In case of 3 indoor units connection

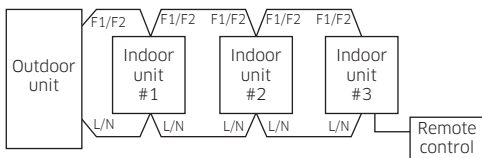

- In case of 4 indoor units connection

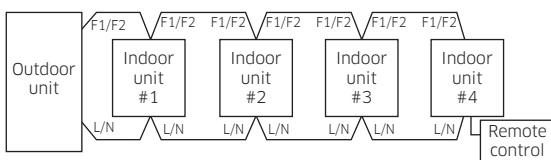

- The wired remote controller can be used with any of the DPM indoor units.

Operation and specification

- The two, the three, or the four sets of the indoor units with DPM installation which are controlled by wired and wireless remote controller work equally. (All controls such as ON/OFF, cooling/heating/dehumidification/ventilation, high/ medium/low wind are equally applied.)
- Thermo OFF which stops when indoor temperature reaches set temperature works by the average sensor value of the indoor temperature of the all indoor units.
- When one of the several indoor units has a problem, they protect operation or stop working.

Instruction for installation and operation

- You should install the DPM according to the above installation specification and eliminate the factors that give electrical load to the both indoor units when installing and operating. (Heater / window / front door / ventilation / partition that divides space)
- You should provide sufficient instructions about the operation method and specification features to users and fill in caution phrases on wired remote controller when necessary.
 - <The air-conditioners in this area are special type to be controlled simultaneously.>

Set up indoor quantity by key switch(K1, K2)

- Press and hold K1 switch to enter the setting mode on the number of the installed indoor unit : Check "A0" sign on 7-segment
 - Press K2 switch to set the number of the installed indoor unit :
 - Ex) If there are two indoor units, press K2 switch twice, and check "A2" sign on 7-segment. If there are three indoor units, press K2 switch three times, and check "A3" sign on 7-segment. If there are four indoor units, press K2 switch four times, and check "A4" sign on 7-segment.
 - Press K1 switch to complete setting the number of the installed indoor unit : Check "AA" sign on 7-segment.

Step 10 Performing the gas leak test

LEAK TEST WITH NITROGEN (before opening valves)

In order to detect basic refrigerant leaks, before recreating the vacuum and recirculating the R-32, it is the responsibility of the installer to pressurize the whole system with nitrogen (using a cylinder with pressure reducer) at a pressure Above 0.2MPa, less than 4MPa (gauge).

LEAK TEST WITH R-32 (after opening valves)

Before opening valves, discharge all the nitrogen into the system and create vacuum. After opening valves check leaks using a leak detector for refrigerant R-32. Once you have completed all the connections, check for possible leaks using leak detector specifically designed for HFC refrigerants.

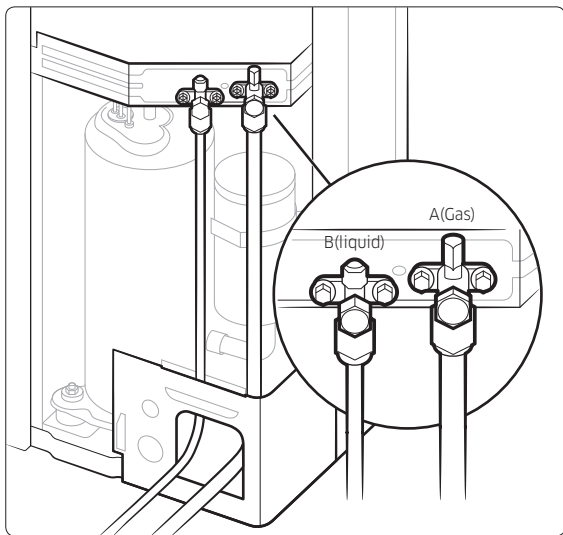

- The designs and shape are subject to change according to the model.

Step 11 Connecting the drain hose to the outdoor unit

When using the air conditioner in the heating mode, ice may accumulate. During de-icing (defrost operation), the condensed water must be drained off safely. Consequently, you must install a drain hose on the outdoor unit, following the instructions below.

- 1 Make space more than 80 mm between the bottom of the outdoor unit and the ground for installation of the drain hose, as shown in figure.
- 2 Insert the drain plug into the hole on the underside of the outdoor unit.
- 3 Connect the drain hose to the drain plug.
- 4 Ensure that the drained water runs off correctly and safely.

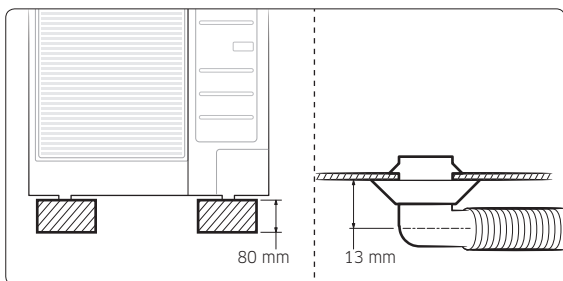

- 5 Be sure to plug the rest of drain holes not connected with drain plugs using drain caps.

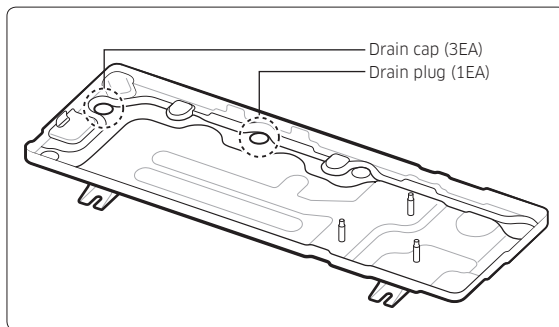

- When installing the product, make sure that the rack is not placed under the drain hole.
- If the product is installed in a region of heavy snow, allow enough separation distance between the product and the ground.

Step 12 Insulating the refrigerant pipes

Once you have checked that there are no leaks in the system, you can insulate the piping and hose.

- 1 To avoid condensation problems, place an insulator around each refrigerant pipe.

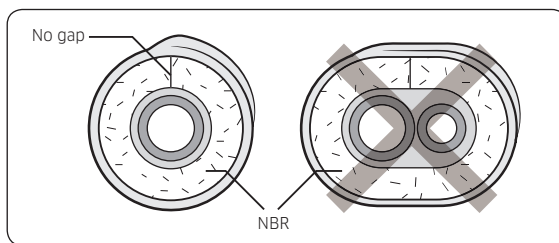

NOTE

- When insulate the pipe, be sure to overlap the insulation.
- The insulation has to be produced in full compliance of European regulation reg. EEC / EU 2037/ 2000 that requires the use of sheaths insulation form without using CFC and HCFC gases for health and the environment.

Installation Procedure

⚠ CAUTION

- When insulating the pipe, use non-slit insulator.
- 2 Select the insulation of the refrigerant pipe.
 - Insulate the gas side and liquid side pipe referring to the thickness according to the pipe size.
 - Less than Indoor temperature of 30°C and humidity of 85% is the standard condition. If installing in a high humidity condition, use one grade thicker insulator by referring to the table below. If installing in an unfavourable conditions, use thicker one.
 - Insulator's heat-resistance temperature should be more than 120°C.

Pipe	Pipe size (mm)	Insulation Type (Heating/Cooling)		Remarks
		Standard [Less than 30°C, 85%]	High humidity [over 30°C, 85%]	
		EPDM, NBR		
Liquid pipe	Ø6.35~Ø9.52	9 t	9 t	Internal temperature is higher than 120°C
	Ø12.7~Ø19.05	13 t	13 t	
Gas pipe	Ø6.35	13 t	19 t	
	Ø9.52~Ø19.05	19 t	25 t	

- When installing insulation in places and conditions below, use the same insulation that is used for high humidity conditions.

<Geological condition>

- High humidity places such as shoreline, hot spring, near lake or river, and ridge (when the part of the building is covered by earth and sand.)

<Operation purpose condition>

- Restaurant ceiling, sauna, swimming pool etc.
- <Building construction condition>
- The ceiling frequently exposed to moisture and cooling is not covered.
- e.g. The pipe installed at a corridor of a dormitory and studio or near an exit that opens and closes frequently.
- The place where the pipe is installed is highly humid due to the lack of ventilation system.

Step 13 Checking the earthing

If the power distribution circuit does not have a earthing or the earthing does not comply with specifications, an earthing electrode must be installed. The corresponding accessories are not supplied with the air conditioner.

- 1 Select an earthing electrode that complies with the specifications given in the illustration.
- 2 Connect the flexible hose to the flexible hose port.
 - In damp hard soil rather than loose sandy or gravel soil that has a higher earthing resistance.
 - Away from underground structures or facilities, such as gas pipes, water pipes, telephone lines and underground cables.
 - At least two metres away from a lightning conductor earthing electrode and its cable.

📄 NOTE

- The earthing wire for the telephone line cannot be used to ground the air conditioner.

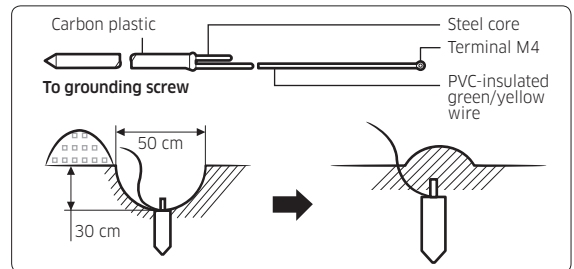

- 3 Finish wrapping insulating tape around the rest of the pipes leading to the outdoor unit.
- 4 Install a green/yellow coloured earthing wire:
 - If the earthing wire is too short, connect an extension lead in a mechanical way and wrap it with insulating tape (do not bury the connection).
 - Secure the earthing wire in position with staples.

📄 NOTE

- If the earthing electrode is installed in an area with heavy traffic, its wire must be connected securely.

- 5 Carefully check the installation by measuring the earthing resistance with a earth resistance tester. If the resistance is above the required level, drive the electrode deeper into the ground or increase the number of earthing electrodes.
- 6 Connect the earthing wire to the electrical component box inside of the outdoor unit.

Step 14 Performing final check and trial operation

- 1 Check the power supply between the outdoor unit and the auxiliary circuit breaker.
 - 1 phase power supply : L, N
 - 3 phase power supply : R, S, T, N
- 2 Check the indoor unit.
 - a Check that you have connected the power and communication cables correctly. (If the power cable and communication cables one mixed up or connected incorrectly, the PCB will be damaged.)
 - b Check that the thermistor sensor, drain pump/hose, and display are connected correctly.
- 3 Press K1 or K2 on the outdoor unit PCB to run the test mode and stop.

Key	Push type	Mode	Display				
			SEG 1	SEG 2	SEG 3	SEG 4	
K1	Short	1st	Heating test mode	F	1	8	8
		2nd	Defrost test mode*	F	3	8	8
		3rd	Stop	8	8	8	8
K2	Short	1st	Cooling test	F	2	8	8
		2nd	Inverter check	F	4	8	8
		3rd	Pump down	F	6	8	8
K3	Short	1st	Reset Release Eco mode	8	8	8	8

※ Defrost test mode

Condition 1: The outdoor temperature is below 10°C.

Condition 2: All the temperature conditions should meet the defrost conditions.

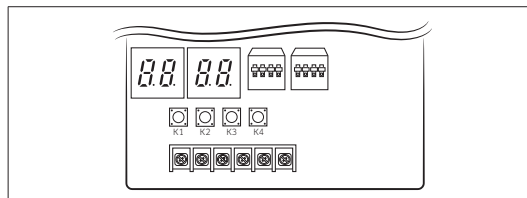

- 4 After 12 minutes operation check discharged air temperature of indoor unit
 - Cooling mode (indoor unit check) → Inlet air temp. - Outlet air temp.: From 10°C to 12°C
 - Heating mode (indoor unit check) → Outlet air temp. - Inlet air temp.: From 11°C to 14°C
 - In heating mode, the indoor fan motor can remain off to avoid cold air blown into air-conditioned space.
 - 5 How to reset the power supply of the outdoor unit and deactivate the eco mode (standby mode):
 - Outdoor unit types A, B : Refer to Outdoor unit dimensions on page 8.
 - Press K3 button over 1 sec to reset the power supply of the outdoor unit and deactivate the eco mode (standby mode).
- ※ Eco mode : Standby for minimizing power consumption

Installation Procedure

6 View mode: When the K4 switch is pressed, you can see information about our system state as below.

K4 short push	Display contents	SEG1	SEG2	SEG3	SEG4	Unit
1	Order frequency	1	Hundreds digit	Tens digit	Units digit	Hz
2	Current frequency	2	Hundreds digit	Tens digit	Units digit	Hz
3	The number of preset indoor units	3	Hundreds digit	Tens digit	Units digit	EA
4	Ambient temperature sensor	4	+ / -	Tens digit	Units digit	°C
5	Compressor discharge sensor	5	Hundreds digit	Tens digit	Units digit	°C
6	Eva Sensor	6	+ / -	Tens digit	Units digit	°C
7	Condensor sensor	7	+ / -	Tens digit	Units digit	°C
8	Current	8	Tens digit	Units digit	The first place of decimals	A
9	Outdoor fan RPM	9	Thousands digit	Hundreds digit	Tens digit	rpm
10	Target discharge temperature	A	Hundreds digit	Tens digit	Units digit	°C
11	EEV	B	Hundreds digit	Tens digit	Units digit	step
12	The capacity sum of indoor units	C	Tens digit	Unit digit	The first place of decimals	kW
13	Protective control	D	0: Cooling 1: Heating	Protective control 0: No Protective control 1: Freezing 2: Non-stop defrosting 3: Over-load 4: Discharge 5: Total electric current	Frequency status 0: Normal 1: Hold 2: Down 3: Up_limit 4: Down_limit	-
14	IPM temperature	E	Hundreds digit	Tens digit	Units digit	-
15	The number of connected indoor units	F	0	Tens digit	Units digit	EA

	Display contents	SEG1	SEG2	SEG3	SEG4	
K4 long push	-	Main micom version	Year (Dec)	Month (Hex)	Date (Tens digit)	Date (Units digit)
	After short push 1	Inverter micom version	Year (Dec)	Month (Hex)	Date (Tens digit)	Date (Units digit)
	After short push 1	E2P version	Year (Dec)	Month (Hex)	Date (Tens digit)	Date (Units digit)
	After short push 1	Page 1 - AUTO Page 2 - (SEG1,2 - Indoor : "A","0") (SEG3,4 - Address : ex)00)				
	After short push 1	Page 1 - MANU Page 2 - (SEG1,2 - Indoor : "A","0") (SEG3,4 - Address : ex)00)				

- Long push K4 (Main micom ver.) → short push 1 more (Inv. micom ver.) → short push 1 more (E2P. ver.)

7 Setting outdoor unit option switch and address manually

a Setting the option

- Press and hold K2 to enter the option setting. (Only available when the operation is stopped)
 - If you enter the option setting, display will show the following.

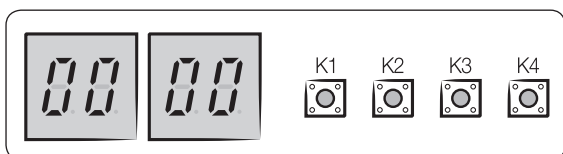

- Seg 1 and Seg 2 will display the number for selected option.
- Seg 3 and Seg 4 will display the number for set value of the selected option.
- If you have selected desired option, you can shortly press the K2 switch to adjust the value of the Seg 3, Seg 4 and change the function for the selected option.

Example)

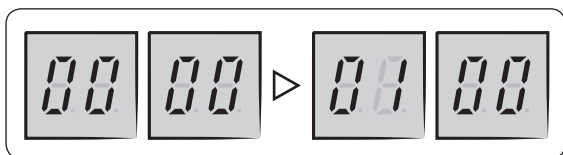

- If you have selected desired option, you can shortly press the K2 switch to adjust the value of the Seg 3, Seg 4 and change the function for the selected option.

Example)

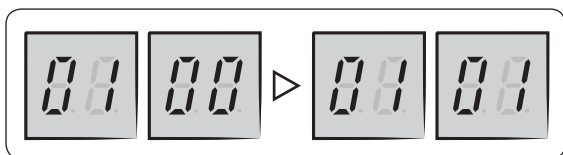

- After selecting the function for options, press and hold the K2 switch for 2 seconds. Edited value of the option will be saved when entire segments blinks and tracking mode begins.

Option item	Input unit	SEG1	SEG2	SEG3	SEG4	Function
Channel address	Main	0	0	A	U	Automatic setting (Factory default)
				00~15		Manual setting
Snow accumulation prevention control	Main	0	1	0	0	Disabled (Factory default)
				0	1	Enabled
Step for Silence mode	Main	0	2	0	0	Disabled (Factory default)
				0	1	Step1
				0	2	Step2
				0	3	Step3
Type of Silence mode	Main	0	3	0	0	Automatic Silence mode (Factory default)
				0	1	Manual Silence mode

⚠ CAUTION

- Edited option will not be saved if you do not end the option setting as explained in above instruction.
- ※ While you are setting the option, you may press and hold the K1 button to reset the value to previous setting.
- ※ If you want to restore the setting to factory default, press and hold the K4 button while you are in the option setting mode.
 - If you press and hold the K4 button, setting will be restored to factory default but it doesn't mean that restored setting is saved. Press and hold the K2 button. When the segments shows that tracking mode is in progress, setting will be saved.

Extra Procedures

Pumping down refrigerant

WARNING

- After installing the product, be sure to perform leak tests on the piping connections. After pumping down refrigerant to inspect or relocate the outdoor unit, be sure to stop the compressor and then remove the connected pipes.
 - Do not operate the compressor while a valve is open due to refrigerant leakage from a pipe or an unconnected or incorrectly connected pipe. Failure to do so may cause air to flow into the compressor and too a high pressure to develop inside the refrigerant circuit, leading to an explosion or product malfunction.

Pump-down is an operation intended to collect all the system refrigerant in the outdoor unit. This operation must be carried out before disconnecting the refrigerant pipe in order to avoid refrigerant loss to the atmosphere.

- 1 Turn the system on in cooling with fan operating at high velocity and then let the compressor run for more than 5 minutes. (Compressor will immediately start, provided 3 minutes have elapsed since the last stop.)
- 2 Release the valve caps on High and Low pressure side.
- 3 Use L-wrench to close the valve on the high pressure side.
- 4 After approximately 2 minute, close the valve on the low pressure side.
- 5 Stop operation of the air conditioner by pressing the (Power) button on the indoor unit or remote control.
- 6 Disconnect the pipes.

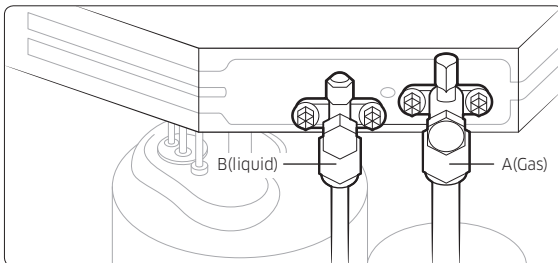

Relocating the indoor and outdoor units

- 1 Pump down refrigerant. See **Pumping down refrigerant** on page 32.
- 2 Remove the power cord.
- 3 Disconnect the assembly cable from the indoor and outdoor units.
- 4 Remove the flare nuts connecting the indoor units and the pipes. At this time, cover the pipes of the indoor unit and the other pipes using a cap or vinyl plug to avoid foreign material entering.
- 5 Disconnect the pipes connected to the outdoor units. At this time, cover the valve of the outdoor units and the other pipes using a cap or vinyl plug to avoid foreign material entering.

Note: Make sure you do not bend the connection pipes in the middle and store together with the cables.
- 6 Move the indoor and outdoor units to a new location.
- 7 Remove the mounting plate for the indoor unit and move it to a new location.

Using the stop valve

Opening the stop valve

- 1 Open the cap and turn the stop valve anticlockwise by using a hexagonal wrench.
- 2 Turn it until the axis is stopped.

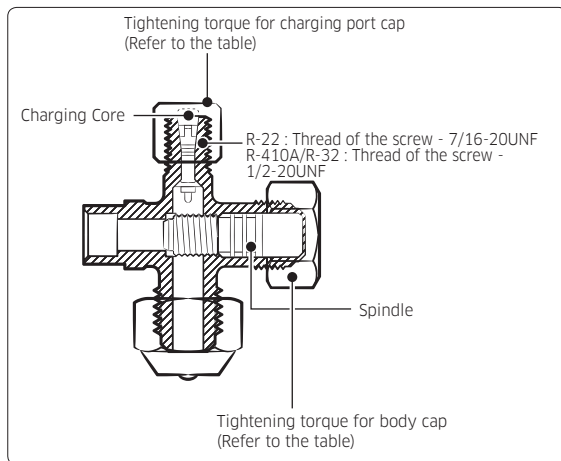

- 3 Tighten the cap securely.

Outer Diameter (mm)	Tightening torque	
	Body cap (N · m)	Charging port cap (N · m)
Ø6.35	20 to 25	10 to 12
Ø9.52	20 to 25	
Ø12.70	25 to 30	
Ø15.88	30 to 35	
Over Ø19.05	35 to 40	

(1 N · m = 10 kgf · cm)

NOTE

- Do not apply excessive force to the stop valve and always use special instruments. Otherwise, the stopping box can be damaged and the back sheet can leak.
- If the watertight sheet leaks, turn the axis back by half, tighten the stopping box, then check the leakage again. If there is no leakage any more, tighten the axis entirely.

Closing the stop valve

- 1 Remove the cap.
- 2 Turn the stop valve clockwise by using a hexagonal wrench.
- 3 Tighten the axis until the valve reached the sealing point.
- 4 Tighten the cap securely.

CAUTION

- When you use the service port, always use a charging hose, too.
- Check the leakage of refrigerant gas after tightening the cap.
- Must use a spanner and wrench when you open/ tighten the stop valve.

Maintenance Procedures

Performing the gas leak tests for repair

In case of repair of the refrigerant circuit, the following procedure must be kept to consider flammability.

- 1 Remove the refrigerant.
- 2 Purge the refrigerant circuit with inert gas.
- 3 Perform evacuation.
- 4 Purge the circuit again with inert gas.
- 5 Open the circuit.
- 6 Perform repair work.
- 7 Charge the system with refrigerant.
- 8 Flush the system with nitrogen blowing for safety.
- 9 Repeat the previous steps several times until no refrigerant is within the system.

CAUTION

- Compressed air or oxygen shall not be used.
- Flush the system with nitrogen blowing, fill the refrigerant until the working pressure is reached, ventilate to atmosphere, and then pull down to a vacuum state.
- For the final nitrogen blowing charge, the system shall be ventilated down to atmospheric pressure.
- The procedure is absolutely vital in case of brazing on the pipings.
- Make sure that the outlet of the vacuum pump is not closed to any ignition sources and there is ventilation available.
- Do not apply any permanent inductive or capacitance loads to the circuit without ensuring that this will not exceed the permissible voltage and current permitted for the air conditioner.

Decommissioning

The following requirements must be fulfilled before and while taking the decommissioning procedure:

- Before decommissioning, the worker shall be familiar with the product details.
 - The entire refrigerant shall be recovered safely.
 - Before starting the process, oil and refrigerant samples shall be taken just in case analysis is required for reuse.
 - Before starting the process, power supply must be available.
- 1 Be familiar with the equipment details.
 - 2 Isolate the system electrically.
 - 3 Before starting the process, make sure that:
 - Any mechanical equipment is available for handling refrigerant cylinders.
 - All PPE (personal protective equipment) is available for servicing.
 - The recovery process shall be supervised by a competent person.
 - The recovery equipment and cylinders comply with the standards.
 - 4 Lower the refrigeration system, if possible.
 - 5 If vacuuming is not possible, make a manifold so that refrigerant can be easily removed from the parts of the system.
 - 6 Make sure that the cylinders are placed on the scales before recovery.
 - 7 Run the recovery system in accordance with the manufacturer's instructions.
 - 8 Do not overcharge the cylinders. (No more than 80 %)
 - 9 Be sure to keep the cylinder within the maximum working pressure, even temporarily.
 - 10 After charging, make sure that the cylinders and the equipment are promptly removed from the site and all isolation valves are closed.
 - 11 Recovered refrigerant shall not be charged into other refrigeration system unless it is cleaned and checked.

Appendix

Troubleshooting

The table below list the self-diagnostic routines. For some of error codes, you must contact an authorized service centre.

If an error occurs during the operation, it is displayed on the outdoor unit PCB LED, both MAIN PCB and INVERTER PCB.

No.	Error Code	Meaning	Remarks
1	E108	Error due to duplicated communication address	Check on repeated indoor unit main address
2	E121	Error on room temperature sensor of indoor unit (Short or Open)	Indoor unit Room Thermistor Open/Short
3	E122	Error on EVA IN sensor of indoor unit (Short or Open)	Indoor unit EVA_IN Thermistor Open/Short
4	E123	Error on EVA OUT sensor of indoor unit (Short or Open)	Indoor unit EVA_OUT Thermistor Open/Short
5	E153	Error on float switch (2nd detection)	Indoor unit Float Switch Open/Short Drain Pump operation Check
6	E154	Indoor fan error	Check on indoor unit indoor Fan operation
7	E198	Error on thermal fuse of indoor unit (Open)	Thermal Fuse Open Check of indoor unit Terminal Block
8	E201	Communication error between the indoor unit and outdoor unit (Pre-tracking failure or when the actual number of indoor units are different from the indoor unit quantity setting on the outdoor unit) Error due to communication tracking failure after initial power is supplied (The error occurs regardless of the number of units.)	Check indoor quantity setting in outdoor
9	E202	Communication error between indoor unit and outdoor unit (When there is no response from indoor units after tracking is completed)	Check electrical connection and setting between indoor unit and outdoor unit
10	E203	Communication error between the outdoor unit and main micom (For PF #4 to #6 controllers, error will be determined from the time when the compressor is turned on.)	Check electrical connection and setting between outdoor unit MAIN PBA - INVERTER PBA
11	E221	Error on outdoor temperature sensor (Short or Open)	Check Outdoor sensor Open / Short
12	E231	Error on outdoor COND OUT sensor (Short or Open)	Check Cond-Out sensor Open / Short
13	E251	Error on discharge temperature sensor of compressor 1 (Short or Open)	Check Discharge sensor Open / Short
14	E320	Error on OLP sensor (Short or Open)	Check OLP sensor Open / Short
15	E403	Compressor down due to freeze protection control	Check Outdoor Cond.
16	E404	System stop due to overload protection control	Check Comp. when it starts
17	E416	System stop due to discharge temperature	-
18	E422	Blockage detected on high pressure pipe	1. Check if the service valve is open 2. Check for refrigerant leakage (pipe connections, heat exchanger) and charge refrigerant if necessary 3. Check if there's any blockage on the refrigerant cycle (indoor unit/outdoor unit) 4. Check if additional refrigerant has been added after pipe extension
19	E425	Reverse phase or open phase	Check whether 3 phase is reversed or opened.
20	E440	Heating operation restricted at outdoor temperature over Theat_high value (default:30°C)	1. Check the range of temperature limited for heating operation 2. Check the outdoor temperature sensor
21	E441	Cooling operation restricted at outdoor temperature below Tcool_low value (default:0°C)	1. Check the range of temperature limited for cooling operation 2. Check the outdoor temperature sensor

Appendix

No.	Error Code	Meaning	Remarks
22	E458	Fan speed error	FAN1 ERROR
23	E461	Error due to operation failure of inverter compressor	-
24	E462	System stop due to full current control	-
25	E463	Over current trip / PFC over current error	Check OLP sensor
26	E464	IPM Over Current(O.C)	1. Check if the service valve is open 2. Check the state of refrigerant 3. Check if connecting wire and the pipe are OK 4. Check the compressor
27	E465	Comp. Over load error	-
28	E466	DC-Link voltage under/over error	Check AC Power and DC Link Voltage
29	E467	Error due to abnormal rotation of the compressor or unconnected wire of compressor	Check Comp wire
30	E468	Error on current sensor (Short or Open)	Check Outdoor Inverter PBA.
31	E469	Error on DC-Link voltage sensor (Short or Open)	-
32	E470	Outdoor unit EEPROM Read/Write error (Option)	Check Outdoor EEPROM Data
33	E471	Outdoor unit EEPROM Read/Write error (H/W)	Check Outdoor EEPROM PBA
34	E474	Error on IPM Heat Sink sensor of inverter 1 (Short or Open)	Check Outdoor Inverter PBA.
35	E475	Error on inverter fan 2	FAN2 ERROR
36	E483	Overvoltage of H/W detect DC link	Check AC Power
37	E484	PFC Overload (Over current) Error	Check Outdoor Inverter PBA.
38	E485	Error on input current sensor of inverter 1 (Short or Open)	Check Outdoor EEPROM PBA
39	E488	Inverter input voltage sensor error	Check Outdoor Inverter PBA
40	E500	IPM over heat error on inverter 1	Check Outdoor Inverter PBA.
41	E508	Smart install is not installed	-
42	E554	Gas leak detected	Check the refrigerant
43	E556	Error due to mismatching capacity of indoor and outdoor unit	Check the indoor and outdoor unit capacity
44	E557	DPM remote controller option error	Check the indoor option code
45	E563	Error due to mismatching indoor and outdoor unit	Check the outdoor EEPROM data and indoor option code
46	E590	Inverter EEPROM Checksum error	-

Technical specifications

Model	Net weight (kg)	Net dimension (W × D × H)
AC100RXADKG	75.0	940 mm × 330 mm × 998 mm
AC100RXADNG	74.0	940 mm × 330 mm × 998 mm
AC120RXADKG	81.0	940 mm × 330 mm × 998 mm
AC120RXADNG	80.0	940 mm × 330 mm × 998 mm
AC140RXADKG	91.5	940 mm × 330 mm × 1210 mm
AC140RXADNG	90.5	940 mm × 330 mm × 1210 mm

COMMISSION DELEGATED REGULATION (EU) No 626/2011ⁱ⁾

PRODUCT FICHE (ENERGY LABELLING OF AIR CONDITIONERS)ⁱⁱ⁾

A	Supplier's name	-	Samsung Electronics Co., Ltd.					
B	Model name (Indoor/Outdoor)	-	AC100RN4DKG/ AC100RXADKG	AC100RN4DKG/ AC100RXADNG	AC120RN4DKG/ AC120RXADKG	AC120RN4DKG/ AC120RXADNG	AC100RN4PKG/ AC100RXADKG	AC100RN4PKG/ AC100RXADNG
C	Sound Power Level (Indoor/Outdoor)	dB(A)	61 / 69	61 / 69	61 / 70	61 / 70	61 / 69	61 / 69
D	Refrigerant name ¹⁾	-	R-32	R-32	R-32	R-32	R-32	R-32
E	GWP	-	675	675	675	675	675	675
F	SEER	-	7,0	7,0	6,0	6,0	6,8	6,8
G	Energy efficiency class (SEER)	-	A++	A++	A+	A+	A++	A++
H	Q _{EE} ²⁾ (cooling season)	kWh/a ⁱⁱⁱ⁾	500	500	700	700	515	515
I	Pdesignc	kW	10,0	10,0	12,0	12,0	10,0	10,0
J	SCOP (Average)	-	4,3	4,3	4,0	4,0	4,3	4,3
K	Energy efficiency class SCOP (Average)	-	A+	A+	A+	A+	A+	A+
L	Q _{HE} ³⁾ heating season (Average)	kWh/a ⁱⁱⁱ⁾	1726	1726	2275	2275	1726	1726
M	Pdesignh (Average)	kW	5,3	5,3	6,5	6,5	5,3	5,3
N	Back up heating capacity(Average)	kW	0	0	0	0	0	0
O	Declared capacity (Average)	kW	5,3	5,3	6,5	6,5	5,3	5,3
P	Other heating seasons suitable for use	-	- ^{iv)}					
Q	SCOP (Warmer)	-	-	-	-	-	-	-
R	Energy efficiency class SCOP (Warmer)	-	-	-	-	-	-	-
S	Q _{HE} ³⁾ heating season (Warmer)	kWh/a ⁱⁱⁱ⁾	-	-	-	-	-	-
T	Pdesignh (Warmer)	kW	-	-	-	-	-	-
U	Back up heating capacity (Warmer)	kW	-	-	-	-	-	-
V	Declared capacity (Warmer)	kW	-	-	-	-	-	-
W	SCOP (Colder)	-	-	-	-	-	-	-
X	Energy efficiency class SCOP (Colder)	-	-	-	-	-	-	-
Y	Q _{HE} ³⁾ heating season (Colder)	kWh/a ⁱⁱⁱ⁾	-	-	-	-	-	-
Z	Pdesignh (Colder)	kW	-	-	-	-	-	-
AA	Back up heating capacity (Colder)	kW	-	-	-	-	-	-
AB	Declared capacity (Colder)	kW	-	-	-	-	-	-

- 1 Refrigerant leakage contributes to climate change. Refrigerant with lower global warming potential (GWP) would contribute less to global warming than a refrigerant with higher GWP, if leaked to the atmosphere.

This appliance contains a refrigerant fluid with a GWP equal to [675]. This means that if 1 kg of this refrigerant fluid would be leaked to the atmosphere, the impact on global warming would be [675] times higher than 1 kg of CO₂, over a period of 100 years.

Never try to interfere with the refrigerant circuit yourself or disassemble the product yourself and always ask a professional.

- 2 Energy consumption "XYZ" kWh per year, based on standard test results.
Actual energy consumption will depend on how the appliance is used and where it is located.
- 3 Energy consumption "XYZ" kWh per year, based on standard test results. Actual energy consumption will depend on how the appliance is used and where it is located.

Appendix

COMMISSION DELEGATED REGULATION (EU) No 626/2011ⁱ⁾

PRODUCT FICHE (ENERGY LABELLING OF AIR CONDITIONERS)ⁱⁱ⁾

A	Supplier's name	-	Samsung Electronics Co., Ltd.					
B	Model name (Indoor/Outdoor)	-	AC120RN4PKG/ AC120RXADKG	AC120RN4PKG/ AC120RXADNG	AC100RNMDKG/ AC100RXADKG	AC100RNMDKG/ AC100RXADNG	AC120RNMDKG/ AC120RXADKG	AC120RNMDKG/ AC120RXADNG
C	Sound Power Level (Indoor/Outdoor)	dB(A)	61 / 70	61 / 70	58 / 69	58 / 69	62 / 70	62 / 70
D	Refrigerant name ¹⁾	-	R-32	R-32	R-32	R-32	R-32	R-32
E	GWP	-	675	675	675	675	675	675
F	SEER	-	6,0	6,0	5,9	5,9	5,8	5,8
G	Energy efficiency class (SEER)	-	A+	A+	A+	A+	A+	A+
H	Q _{ce} ²⁾ (cooling season)	kWh/a ⁱⁱⁱ⁾	700	700	593	593	724	724
I	Pdesignc	kW	12,0	12,0	10,0	10,0	12,0	12,0
J	SCOP (Average)	-	4,0	4,0	4,0	4,0	4,0	4,0
K	Energy efficiency class SCOP (Average)	-	A+	A+	A+	A+	A+	A+
L	Q _{he} ³⁾ heating season (Average)	kWh/a ⁱⁱⁱ⁾	2275	2275	1820	1820	2275	2275
M	Pdesignh (Average)	kW	6,5	6,5	5,2	5,2	6,5	6,5
N	Back up heating capacity(Average)	kW	0	0	0	0	0	0
O	Declared capacity (Average)	kW	6,5	6,5	5,2	5,2	6,5	6,5
P	Other heating seasons suitable for use	-	-iv)					
Q	SCOP (Warmer)	-	-	-	-	-	-	-
R	Energy efficiency class SCOP (Warmer)	-	-	-	-	-	-	-
S	Q _{he} ³⁾ heating season (Warmer)	kWh/a ⁱⁱⁱ⁾	-	-	-	-	-	-
T	Pdesignh (Warmer)	kW	-	-	-	-	-	-
U	Back up heating capacity (Warmer)	kW	-	-	-	-	-	-
V	Declared capacity (Warmer)	kW	-	-	-	-	-	-
W	SCOP (Colder)	-	-	-	-	-	-	-
X	Energy efficiency class SCOP (Colder)	-	-	-	-	-	-	-
Y	Q _{he} ³⁾ heating season (Colder)	kWh/a ⁱⁱⁱ⁾	-	-	-	-	-	-
Z	Pdesignh (Colder)	kW	-	-	-	-	-	-
AA	Back up heating capacity (Colder)	kW	-	-	-	-	-	-
AB	Declared capacity (Colder)	kW	-	-	-	-	-	-

- 1 Refrigerant leakage contributes to climate change. Refrigerant with lower global warming potential (GWP) would contribute less to global warming than a refrigerant with higher GWP, if leaked to the atmosphere.

This appliance contains a refrigerant fluid with a GWP equal to [675]. This means that if 1 kg of this refrigerant fluid would be leaked to the atmosphere, the impact on global warming would be [675] times higher than 1 kg of CO₂, over a period of 100 years.

Never try to interfere with the refrigerant circuit yourself or disassemble the product yourself and always ask a professional.

- 2 Energy consumption "XYZ" kWh per year, based on standard test results.
Actual energy consumption will depend on how the appliance is used and where it is located.
- 3 Energy consumption "XYZ" kWh per year, based on standard test results. Actual energy consumption will depend on how the appliance is used and where it is located.

COMMISSION DELEGATED REGULATION (EU) No 626/2011¹⁾

PRODUCT FICHE (ENERGY LABELLING OF AIR CONDITIONERS)¹⁾

A	Supplier's name	-	Samsung Electronics Co., Ltd.					
B	Model name (Indoor/Outdoor)	-	AC100RNCDKG/ AC100RXADKG	AC100RNCDKG/ AC100RXADNG	AC120RNCDKG/ AC120RXADKG	AC120RNCDKG/ AC120RXADNG	AC100RNTDKG/ AC100RXADKG	AC100RNTDKG/ AC100RXADNG
C	Sound Power Level (Indoor/Outdoor)	dB(A)	60 / 69	60 / 69	62 / 70	62 / 70	65 / 69	65 / 69
D	Refrigerant name ¹⁾	-	R-32	R-32	R-32	R-32	R-32	R-32
E	GWP	-	675	675	675	675	675	675
F	SEER	-	6,1	6,1	5,9	5,9	5,9	5,9
G	Energy efficiency class (SEER)	-	A++	A++	A+	A+	A+	A+
H	Q _{EE} ²⁾ (cooling season)	kWh/a ¹⁰⁾	574	574	712	712	564	564
I	Pdesignc	kW	10,0	10,0	12,0	12,0	9,5	9,5
J	SCOP (Average)	-	4,0	4,0	4,0	4,0	4,0	4,0
K	Energy efficiency class SCOP (Average)	-	A+	A+	A+	A+	A+	A+
L	Q _{HE} ³⁾ heating season (Average)	kWh/a ¹⁰⁾	1820	1820	2275	2275	1960	1960
M	Pdesignh (Average)	kW	5,2	5,2	6,5	6,5	5,6	5,6
N	Back up heating capacity(Average)	kW	0	0	0	0	0	0
O	Declared capacity (Average)	kW	5,2	5,2	6,5	6,5	5,6	5,6
P	Other heating seasons suitable for use	-	- ¹¹⁾					
Q	SCOP (Warmer)	-	-	-	-	-	-	-
R	Energy efficiency class SCOP (Warmer)	-	-	-	-	-	-	-
S	Q _{HE} ³⁾ heating season (Warmer)	kWh/a ¹⁰⁾	-	-	-	-	-	-
T	Pdesignh (Warmer)	kW	-	-	-	-	-	-
U	Back up heating capacity (Warmer)	kW	-	-	-	-	-	-
V	Declared capacity (Warmer)	kW	-	-	-	-	-	-
W	SCOP (Colder)	-	-	-	-	-	-	-
X	Energy efficiency class SCOP (Colder)	-	-	-	-	-	-	-
Y	Q _{HE} ³⁾ heating season (Colder)	kWh/a ¹⁰⁾	-	-	-	-	-	-
Z	Pdesignh (Colder)	kW	-	-	-	-	-	-
AA	Back up heating capacity (Colder)	kW	-	-	-	-	-	-
AB	Declared capacity (Colder)	kW	-	-	-	-	-	-

- 1 Refrigerant leakage contributes to climate change. Refrigerant with lower global warming potential (GWP) would contribute less to global warming than a refrigerant with higher GWP, if leaked to the atmosphere.

This appliance contains a refrigerant fluid with a GWP equal to [675]. This means that if 1 kg of this refrigerant fluid would be leaked to the atmosphere, the impact on global warming would be [675] times higher than 1 kg of CO₂, over a period of 100 years.

Never try to interfere with the refrigerant circuit yourself or disassemble the product yourself and always ask a professional.

- 2 Energy consumption "XYZ" kWh per year, based on standard test results.
Actual energy consumption will depend on how the appliance is used and where it is located.
- 3 Energy consumption "XYZ" kWh per year, based on standard test results. Actual energy consumption will depend on how the appliance is used and where it is located.

Appendix

	[ESPAÑOL-ES]	[FRANÇAIS-FR]	[ITALIANO-IT]	[PORTUGUÊS-PT]	
A	Nombre del proveedor	Nom du fournisseur	Nome del Fornitore	Nome do fornecedor	
B	Nombre del modelo (unidad interior/exterior)	Nom du modèle (intérieur/extérieur)	Nome del Modello (Unità Interna/Unità Esterna)	Nome do modelo (interior/exterior)	
C	Nivel de potencia acústica (interior/exterior)	Niveau de puissance acoustique (intérieur/extérieur)	Livello della potenza sonora (interno/esterno)	Nível de potência sonora (interior/exterior)	
D	Nombre del refrigerante ¹⁾	Nom du fluide frigorigène ¹⁾	Nome del refrigerante utilizzato ¹⁾	Nome do fluido refrigerante ¹⁾	
E	GWP	GWP	GWP	GWP	
F	SEER	SEER	SEER	SEER	
G	Clase de eficiencia energética (SEER)	Classe d'efficacité énergétique (SEER)	Classe di Efficienza Energetica (SEER)	Classe de eficiência energética (SEER)	
H	Q _{CE} ²⁾ (temporada refrigeración)	Q _{CE} ²⁾ (saison froide)	Q _{CE} ²⁾ (stagione di raffreddamento)	Q _{CE} ²⁾ (estação de arrefecimento)	
I	Pdesignc	Pdesignc	Pdesignc	Pdesignc	
J	SCOP (Media)	SCOP (moyenne)	SCOP (media)	SCOP (Média)	
K	Clase de eficiencia energética SCOP (Media)	Classe d'efficacité énergétique SCOP (moyenne)	Classe di efficienza energetica SCOP (media)	Classe de eficiência energética SCOP (Média)	
L	Q _{HE} ³⁾ temporada calefacción (Media)	Q _{HE} ³⁾ saison chaude (moyenne)	Q _{HE} ³⁾ altre stagioni d'uso (media)	Q _{HE} ³⁾ estação de aquecimento (Média)	
M	Pdesignh (Media)	Pdesignh (moyenne)	Pdesignh (media)	Pdesignh (Média)	
N	Copia de seguridad de capacidad de calefacción (Media)	Sauvegarder la capacité de chauffage (moyenne)	Eseguire il backup di potenza termica (media)	Fazer backup de capacidade de aquecimento (Média)	
O	Potencia declarada (Media)	Puissance frigorifique déclarée (moyenne)	Capacità dichiarata (media)	Capacidade declarada (Média)	
P	Otras temporadas de calefacción declaradas aptas para funcionar	Adapté à d'autres saisons chaudes	Altre stagioni di utilizzo	Outras estações de aquecimento adequadas para utilização	
Q	SCOP (Más cálida)	SCOP (plus chaude)	SCOP (Stagione più calda)	SCOP (Mais quente)	
R	Clase de eficiencia energética SCOP (Más cálida)	Classe d'efficacité énergétique SCOP (plus chaude)	Classe di efficienza energetica (Stagione più calda)	Classe de eficiência energética SCOP (Mais quente)	
S	Q _{HE} ³⁾ temporada calefacción (Más cálida)	Q _{HE} ³⁾ saison chaude (plus chaude)	Q _{HE} ³⁾ altre stagioni d'uso (Stagione più calda)	Q _{HE} ³⁾ estação de aquecimento (Mais quente)	
T	Pdesignh (Más cálida)	Pdesignh (plus chaude)	Pdesignh (Stagione più calda)	Pdesignh (Mais quente)	
U	Copia de seguridad de capacidad de calefacción (Más cálida)	Sauvegarder la capacité de chauffage (plus chaude)	Eseguire il backup di potenza termica (Stagione più calda)	Fazer backup de capacidade de aquecimento (Mais quente)	
V	Potencia declarada (Más cálida)	Puissance frigorifique déclarée (plus chaude)	Capacità dichiarata (Stagione più calda)	Capacidade declarada (Mais quente)	
W	SCOP (Más fría)	SCOP (plus froide)	SCOP (stagione più fredda)	SCOP (Mais fria)	
X	Clase de eficiencia energética SCOP (Más fría)	Classe d'efficacité énergétique SCOP (plus froide)	Classe di efficienza energetica (Stagione più fredda)	Classe de eficiência energética SCOP (Mais fria)	
Y	Q _{HE} ³⁾ temporada calefacción (Más fría)	Q _{HE} ³⁾ saison chaude (plus froide)	Q _{HE} ³⁾ altre stagioni d'uso (Stagione più fredda)	Q _{HE} ³⁾ estação de aquecimento (Mais fria)	
Z	Pdesignh (Más fría)	Pdesignh (plus froide)	Pdesignh (Stagione più fredda)	Pdesignh (Mais fria)	
AA	Copia de seguridad de capacidad de calefacción (Más fría)	Sauvegarder la capacité de chauffage (plus froide)	Eseguire il backup di potenza termica (Stagione più fredda)	Fazer backup de capacidade de aquecimento (Mais fria)	
AB	Potencia declarada (Más fría)	Puissance frigorifique déclarée (plus froide)	Capacità dichiarata (Stagione più fredda)	Capacidade declarada (Mais fria)	
i	REGLAMENTO DELEGADO (UE) No 626/2011 DE LA COMISIÓN	RÈGLEMENT DÉLÉGUÉ (UE) No 626/2011 DE LA COMMISSION	REGOLAMENTO DELEGATO (UE) N. 626/2011 DELLA COMMISSIONE	REGULAMENTO DELEGADO (UE) N.º 626/2011 DA COMISSÃO	
ii	Ficha del producto etiquetado energético de los acondicionadores de aire	Fiche produit (l'indication, par voie d'étiquetage, de la consommation d'énergie des climatiseurs)	Scheda prodotto (l'etichettatura indicante il consumo d'energia dei condizionatori d'aria)	Ficha de produto (rotulagem energética dos aparelhos de ar condicionado)	
iii	kWh/a	kWh/a	kWh/a	kWh/a	
iv	Warmer	Más cálida	Plus chaude	Stagione più calda	Mais quente
	Colder	Más fría	Plus froide	Stagione più fredda	Mais fria
	Warmer & Colder	Más cálida & Más fría	Plus chaude & Plus froide	Stagione più calda & Stagione più fredda	Mais quente & Mais fria

	[DEUTSCH-DE]	[ΕΛΛΗΝΙΚΑ-EL]	[NEDERLANDS-NL]	[POLSKI-PL]	
A	Name des Lieferanten	Όνομα προμηθευτή	Naam van de leverancier	Nazwa dostawcy	
B	Modellbezeichnung (Innen-/Außengerät)	Ονομασία μοντέλου (εσωτερικού χώρου/εξωτερικού χώρου)	Modelnaam (binnen/buiten)	Nazwa modelu (Wewnętrzny/zewnętrzny)	
C	Schalleistungspegel (innen/außen)	Στάθμη ηχητικής ισχύος (εσωτερικού/εξωτερικού χώρου)	Geluidsniveau (binnen/buiten)	Poziom mocy akustycznej (Wewnętrzna/zewnętrzna)	
D	Name des Kältemittels ¹⁾	Όνομα ψυκτικού μέσου ¹⁾	Koelmiddel ¹⁾	Nazwa środka chłodzącego ¹⁾	
E	GWP	GWP	GWP	GWP	
F	SEER	SEER	SEER	SEER	
G	Energieeffizienzklasse (SEER)	Τάξη ενεργειακής απόδοσης (SEER)	Energie-efficiencyklasse (SEER)	Klasa energetyczna (SEER)	
H	Q _{ce} ²⁾ (Kühlperiode)	Q _{ce} ²⁾ (εποχή ψύξης)	Q _{ce} ²⁾ (koelingsseizoen)	Q _{ce} ²⁾ (okres chłodzenia)	
I	Pdesignc	Pdesignc	Pdesignc	Pdesignc	
J	SCOP (mittel)	SCOP (μέση εποχή)	SCOP (gemiddeld)	SCOP (średnie)	
K	Energieeffizienzklasse SCOP (mittel)	Τάξη ενεργειακής απόδοσης SCOP (μέση εποχή)	Energie-efficiencyklasse SCOP (gemiddeld)	Klasa energetyczna SCOP (średnie)	
L	Q _{he} ³⁾ Heizperiode (mittel)	Q _{he} ³⁾ εποχή θέρμανσης (μέση εποχή)	Q _{he} ³⁾ verwarmingsseizoen (gemiddeld)	Q _{he} ³⁾ okres grzewczy (średnie)	
M	Pdesignh (mittel)	Pdesignh (μέση εποχή)	Pdesignh (gemiddeld)	Deklarowane obciążenie grzewcze (średnie)	
N	Sichern Heizleistung (mittel)	Δημιουργία αντιγράφων ασφαλείας ικανότητα θέρμανσης (μέση εποχή)	Verwarmingsovercapaciteit (gemiddeld)	Wydajność rezerwowego podgrzewacza elektrycznego (średnia)	
O	Angegebene Leistung (mittel)	Δηλωμένη ψυκτική ισχύς (μέση εποχή)	Opgegeven capaciteit (gemiddeld)	Deklarowana wydajność (średnia)	
P	Weitere geeignete Heizperioden	Άλλες εποχές θέρμανσης που είναι κατάλληλο για χρήση	Andere verwarmingsseizoenen geschikt voor gebruik	Inne okresy grzania odpowiednie do użytku	
Q	SCOP (wärmer)	SCOP (μέση εποχή)	SCOP (warmer)	SCOP (cieplej)	
R	Energieeffizienzklasse SCOP (wärmer)	Τάξη ενεργειακής απόδοσης SCOP (μέση εποχή)	Energie-efficiencyklasse SCOP (warmer)	Klasa energetyczna SCOP (cieplej)	
S	Q _{he} ³⁾ Heizperiode (wärmer)	Q _{he} ³⁾ εποχή θέρμανσης (μέση εποχή)	Q _{he} ³⁾ verwarmingsseizoen (warmer)	Q _{he} ³⁾ okres grzewczy (cieplej)	
T	Pdesignh (wärmer)	Pdesignh (θερμότερη εποχή)	Pdesignh (warmer)	Deklarowane obciążenie grzewcze (cieplej)	
U	Sichern Heizleistung (wärmer)	Δημιουργία αντιγράφων ασφαλείας ικανότητα θέρμανσης (θερμότερη εποχή)	Verwarmingsovercapaciteit (warmer)	Wydajność rezerwowego podgrzewacza (cieplej)	
V	Angegebene Leistung (wärmer)	Δηλωμένη ψυκτική ισχύς (θερμότερη εποχή)	Opgegeven capaciteit (warmer)	Deklarowana wydajność (cieplej)	
W	SCOP (kälter)	SCOP (μέση εποχή)	SCOP (kouder)	SCOP (zimniej)	
X	Energieeffizienzklasse SCOP (mittel)	Τάξη ενεργειακής απόδοσης SCOP (μέση εποχή)	Energie-efficiencyklasse SCOP (kouder)	Klasa energetyczna SCOP (zimniej)	
Y	Q _{he} ³⁾ Heizperiode (mittel)	Q _{he} ³⁾ εποχή θέρμανσης (μέση εποχή)	Q _{he} ³⁾ verwarmingsseizoen (kouder)	Q _{he} ³⁾ okres grzewczy (zimniej)	
Z	Pdesignh (kälter)	Pdesignh (ψυχρότερη εποχή)	Pdesignh (kouder)	Deklarowane obciążenie grzewcze (zimniej)	
AA	Sichern Heizleistung (kälter)	Δημιουργία αντιγράφων ασφαλείας ικανότητα θέρμανσης (ψυχρότερη εποχή)	Verwarmingsovercapaciteit (kouder)	Wydajność rezerwowego podgrzewacza (zimniej)	
AB	Angegebene Leistung (kälter)	Δηλωμένη ψυκτική ισχύς (ψυχρότερη εποχή)	Opgegeven capaciteit (kouder)	Deklarowana wydajność (zimniej)	
i	DELEGIERTE VERORDNUNG (EU) Nr. 626/2011 DER KOMMISSION	ΚΑΤ' ΕΞΟΥΣΙΟΔΟΤΗΣΗ ΚΑΝΟΝΙΣΜΟΣ (ΕΕ) αριθ. 626/2011 ΤΗΣ ΕΠΙΤΡΟΠΗΣ	COMMISSIE GEDELEGEERDE VERORDENING (EU) Nr. 626/2011	ROZPORZĄDZENIE DELEGOWANE KOMISJI (UE) NR 626/2011	
ii	Produktdatenblatt (die Kennzeichnung von Luftkonditionierern in Bezug auf den Energieverbrauch)	Δελτίο προϊόντος (επισήμανση της κατανάλωσης ενέργειας των κλιματιστικών)	PRODUCTKAART (ENERGIELABEL VOOR AIRCONDITIONERS)	KARTA PRODUKTU (OZNACZENIE KLIMATYZATORÓW ODNOŚĄCE SIĘ DO ICH ZUŻYCIA ENERGII)	
iii	kWh/a	kWh/έτος	kWh/a	kWh/a	
iv	Warmer	Wärmer	Θερμότερη εποχή	Warmer	Cieplej
	Colder	Kälter	Ψυχρότερη εποχή	Kouder	Zimniej
	Warmer & Colder	Wärmer & Kälter	Θερμότερη εποχή & Ψυχρότερη εποχή	Warmer & Kouder	Cieplej & Zimniej

Appendix

	[MAGYAR-HU]	[ČEŠTINA-CS]	[SLOVENČINA-SK]	[ROMÂNĂ-RO]
A	Forgalmazó neve	Název dodavatele	Názov dodávateľa	Numele furnizorului
B	Modellnév (Beltéri/kültéri)	Název modelu (vnitřní/venkovní)	Názov modelu (vnútorné/vonkajšie)	Numele modelului (interior/exterior)
C	Zajszint (Beltéri/kültéri)	Hladina akustického výkonu (vnitřní/venkovní)	Hladina akustického výkonu (vnútorná/vonkajšia)	Nivel de putere acustică (interior/exterior)
D	Hűtőközeg neve ¹⁾	Název chladiva ¹⁾	Chladivo ¹⁾	Numele agentului frigorific ¹⁾
E	GWP	GWP	GWP	GWP
F	SEER	SEER	SEER	SEER
G	Energiahatékonysági osztály (SEER)	Třída energetické účinnosti (SEER)	Trieda energetickej účinnosti (SEER)	Clasă de eficiență energetică (SEER)
H	Q _{ce} ²⁾ (hűtési szezon)	Q _{ce} ²⁾ (období chlazení)	Q _{ce} ²⁾ (sezóna chladenia)	Q _{ce} ²⁾ (perioadă de răcire)
I	Pdesignc	Pdesignc	Pdesignc	Pdesignc
J	SCOP (átlagos)	SCOP (průměr)	SCOP (Priemerná)	SCOP (mediu)
K	Energiahatékonysági osztály SCOP (átlagos)	Třída energetické účinnosti SCOP (průměrný)	Trieda energetickej účinnosti SCOP (Priemerná)	Clasă de eficiență energetică SCOP (mediu)
L	Q _{he} ³⁾ fűtési szezon (átlagos)	Q _{he} ³⁾ období topení (průměrný)	Q _{he} ³⁾ sezóna vykurovania (Priemerná)	Q _{he} ³⁾ perioadă de încălzire (mediu)
M	Pdesignh (átlagos)	Pdesignh (průměr)	Pdesignh (Priemerná)	Pdesignh (mediu)
N	Biztonsági fűtőtjeljesítmény (átlagos)	Záložní topný výkon (průměrný)	Zálohovanie vykurovací výkon (Priemerná)	Capacitate de încălzire de rezervă (medie)
O	Névleges teljesítmény (átlagos)	Udávány výkon (průměrný)	Deklarovaný chladiaci výkon (Priemerná)	Capacitate declarată (medie)
P	Egyéb fűtési szezonban használható	Další topné sezony vhodné k použití	Iné sezóny vykurovania, v ktorých je vhodné použitie zariadenia	Alte perioade de încălzire adecvate pentru utilizare
Q	SCOP (melegebb)	SCOP (teplejší)	SCOP (Teplejšia)	SCOP (mai cald)
R	Energiahatékonysági osztály SCOP (melegebb)	Třída energetické účinnosti SCOP (teplejší)	Trieda energetickej účinnosti SCOP (Teplejšia)	Clasă de eficiență energetică SCOP (mai cald)
S	Q _{he} ³⁾ fűtési szezon (melegebb)	Q _{he} ³⁾ období topení (teplejší)	Q _{he} ³⁾ sezóna vykurovania (Teplejšia)	Q _{he} ³⁾ perioadă de încălzire (mai cald)
T	Pdesignh (melegebb)	Pdesignh (teplejší)	Pdesignh (Teplejšia)	Pdesignh (mai cald)
U	Biztonsági fűtőtjeljesítmény (melegebb)	Záložní topný výkon (teplejší)	Zálohovanie vykurovací výkon (Teplejšia)	Capacitate de încălzire de rezervă (mai cald)
V	Névleges teljesítmény (melegebb)	Udávány výkon (teplejší)	Deklarovaný chladiaci výkon (Teplejšia)	Capacitate declarată (mai cald)
W	SCOP (hidegebb)	SCOP (chladnější)	SCOP (Chladnejšia)	SCOP (mai rece)
X	Energiahatékonysági osztály SCOP (hidegebb)	Třída energetické účinnosti SCOP (chladnější)	Trieda energetickej účinnosti SCOP (Chladnejšia)	Clasă de eficiență energetică SCOP (mai rece)
Y	Q _{he} ³⁾ fűtési szezon (hidegebb)	Q _{he} ³⁾ období topení (chladnější)	Q _{he} ³⁾ sezóna vykurovania (Chladnejšia)	Q _{he} ³⁾ perioadă de încălzire (mai rece)
Z	Pdesignh (hidegebb)	Pdesignh (chladnější)	Pdesignh (Chladnejšia)	Pdesignh (mai rece)
AA	Biztonsági fűtőtjeljesítmény (hidegebb)	Záložní topný výkon (chladnější)	Zálohovanie vykurovací výkon (Chladnejšia)	Capacitate de încălzire de rezervă (mai rece)
AB	Névleges teljesítmény (hidegebb)	Udávány výkon (chladnější)	Deklarovaný chladiaci výkon (Chladnejšia)	Capacitate declarată (mai rece)
i	626/2011 BIZOTTSÁGI FELHATALMAZÁSON ALAPULÓ RENDELET (EU)	NAŘÍZENÍ KOMISE V PŘENESENÉ PRAVOMOCI (EU) Č. 626/2011	DELEGOVANÉ NARIADENIE KOMISIE (EÚ) č. 626/2011	REGULAMENTUL DELEGAT (UE) 626/2011 AL COMISIEI
ii	TERMÉK ADATLAP (LÉGKONDITIONÁLÓK ENERGIAHATÉKONYSÁGI CÍMKÉZÉSE)	LIST VÝROBKU (ENERGETICKÉ ŠTÍTKY KLIMATIZACÍ)	Opis výrobku (označovanie klimatizátorov energetickými)	FIȘA PRODUSULUI (ETICHETAREA ENERGETICĂ A APARATELOR DE AER CONDIȚIONAT)
iii	kWh/a	kWh/a	kWh/rok	kWh/a
iv	Warmer	Melegebb	Teplejší	Mai cald
	Colder	Hidegebb	Chladnější	Mai rece
	Warmer & Colder	Melegebb & Hidegebb	Teplejší & Chladnější	Mai cald și mai rece

	[БЪЛГАРСКИ-BG]	[HRVATSKI-HR]	[SLOVENČINA-SL]	[DANSK-DA]	
A	Име на доставчик	Naziv dobavljača	Názov dodávateľa	Leverandørens navn	
B	Име на модел (вътрешно/външно тяло)	Naziv modela (unutarnji/spoljni)	Názov modelu (vnútorná/vonkajšie)	Modelnavn (indendørs/udendørs)	
C	Ниво на акустична мощност (вътрешно/външно тяло)	Razina zvučne snage (u zatvorenom/otvorenom)	Hladina akustického výkonu (vnútorná/vonkajšia)	Lydeffektivniveau (indenfor/udenfor)	
D	Име на хладилен агент ¹⁾	Naziv rashladnog sredstva ¹⁾	Chladivo ¹⁾	Navnet på køleelementet ¹⁾	
E	GWP	GWP	CWP	GWP	
F	SEER	SEER	SEER	SEER	
G	Клас на енергийна ефективност (SEER)	Razred energetske učinkovitosti (SEER)	Trieda energetickej účinnosti (SEER)	Energieffektivitetsklasse (SEER)	
H	Q _{CE} ²⁾ (сезон на охлаждане)	Q _{CE} ²⁾ (sezona hladenja)	Q _{CE} ²⁾ (sezóna chladenia)	Q _{CE} ²⁾ (kølesæson)	
I	Pdesignc	Pdesignc	Pdesignc	Pdesignc	
J	SCOP (среден)	SCOP (Prosječno)	SCOP (Priemerná)	SCOP (gennemsnitlig)	
K	Клас на енергийна ефективност SCOP (среден)	Razred energetske učinkovitosti SCOP (Prosječno)	Trieda energetickej účinnosti SCOP (Priemerná)	Energieffektivitetsklasse SCOP (gennemsnitlig)	
L	Q _{HE} ³⁾ сезон на отопление (среден)	Q _{HE} ³⁾ sezona grijanja (Prosječno)	Q _{HE} ³⁾ sezóna vykurovania (Priemerná)	Q _{HE} ³⁾ varmesæson (gennemsnitlig)	
M	Обявен отоплителен товар (среден)	Pdesignh (Prosječno)	Pdesignh (Priemerná)	Pdesignh (gennemsnitlig)	
N	Капацитет на помощно отопление (среден)	Back up kapacitet grijanja (Prosječno)	Zálohovanie vykurovací výkon (Priemerná)	Backup-varmekapacitet (gennemsnitlig)	
O	Деклариран капацитет (среден)	Prijavljeni kapacitet (Prosječno)	Deklarovaný chladiaci výkon (Priemerná)	Deklareret kapacitet (gennemsnitlig)	
P	Други сезони на отопление, подходящи за използване	Druge sezone grijanja u kojima se može koristiti	Iné sezóny vykurovania, v ktorých je vhodné použitie zariadenia	Andre opvarmingsæsoner, der er beregnet til brug	
Q	SCOP (по-топло)	SCOP (Toplije)	SCOP (Teplejšia)	SCOP (varmere)	
R	Клас на енергийна ефективност SCOP (по-топло)	Razred energetske učinkovitosti SCOP (Toplije)	Trieda energetickej účinnosti SCOP (Teplejšia)	Energieffektivitetsklasse SCOP (varmere)	
S	Q _{HE} ³⁾ сезон на отопление (по-топло)	Q _{HE} ³⁾ sezona grijanja (Toplije)	Q _{HE} ³⁾ sezóna vykurovania (Teplejšia)	Q _{HE} ³⁾ varmesæson (varmere)	
T	Обявен отоплителен товар (по-топло)	Pdesignh (Toplije)	Pdesignh (Teplejšia)	Pdesignh (varmere)	
U	Капацитет на помощно отопление (по-топло)	Back up kapacitet grijanja (Toplije)	Zálohovanie vykurovací výkon (Teplejšia)	Backup-varmekapacitet (varmere)	
V	Деклариран капацитет (по-топло)	Prijavljeni kapacitet (Toplije)	Deklarovaný chladiaci výkon (Teplejšia)	Deklareret kapacitet (varmere)	
W	SCOP (по-студено)	SCOP (Hladnije)	SCOP (Chladnejšia)	SCOP (koldere)	
X	Клас на енергийна ефективност SCOP (по-студено)	Razred energetske učinkovitosti SCOP (Hladnije)	Trieda energetickej účinnosti SCOP (Chladnejšia)	Energieffektivitetsklasse SCOP (koldere)	
Y	Q _{HE} ³⁾ сезон на отопление (по-студено)	Q _{HE} ³⁾ sezona grijanja (Hladnije)	Q _{HE} ³⁾ sezóna vykurovania (Chladnejšia)	Q _{HE} ³⁾ varmesæson (koldere)	
Z	Обявен отоплителен товар (по-студено)	Pdesignh (Hladnije)	Pdesignh (Chladnejšia)	Pdesignh (koldere)	
AA	Капацитет на помощно отопление (по-студено)	Back up kapacitet grijanja (Hladnije)	Zálohovanie vykurovací výkon (Chladnejšia)	Backup-varmekapacitet (koldere)	
AB	Деклариран капацитет (по-студено)	Prijavljeni kapacitet (Hladnije)	Deklarovaný chladiaci výkon (Chladnejšia)	Deklareret kapacitet (koldere)	
i	ДЕЛЕГИРАН РЕГЛАМЕНТ (ЕС) № 626/2011 НА КОМИСИЯТА	DELEGIRANA UREDBA KOMISIJE (EU) br. 626/2011	DELEGOVANÉ NARIADENIE KOMISIE (EÚ) č. 626/2011	KOMMISSIONENS DELEGEREDE FORORDNING (EU) nr. 626/2011	
ii	ПРОДУКТОВ ФИШ (ЕНЕРГИЙНО ЕТИКЕТИРАНЕ НА КЛИМАТИЦИ)	Informacijski list proizvoda (označivanja energetske učinkovitosti)	Opis výrobku (označovanie klimatizátorov energetickými)	DATABLAD (ENERGIMÆRKNING AF KLIMAANLÆG)	
iii	kWh/a	kWh/a	kWh/rok	kWh pr. år	
iv	Warmer	По-топло	Toplije	Teplejšia	Varmere
	Colder	По-студено	Hladnije	Chladnejšia	Koldere
	Warmer & Colder	По-топло и по-студено	Toplije & Hladnije	Teplejšia & Chladnejšia	Varmere og koldere

Appendix

	[SVENSKA-SV]	[SUOMI-FI]	[EESTI-ET]	[LATVIEŠU-LV]	
A	Leverantörens namn	Tavarantoimittajan nimi	Tarnija nimi	Piegādātāja nosaukums	
B	Modellnamn (inomhus/utomhus)	Mallin nimi (sisä/ulko)	Mudeli nimi (sisetingimused/välitingimused)	Modeļa nosaukums (iekštelpu/ārtelpu)	
C	Ljudnivå (inomhus/utomhus)	Äänitehotaso (sisä/ulko)	Helivõimsuse tase (sisetingimused/välitingimused)	Skaņas intensitātes līmenis (iekštelpu/ārtelpu)	
D	Köldmedium ¹⁾	Kylmäaineen nimi ¹⁾	Jahutusaine nimi ¹⁾	Aukstumāģenta nosaukums ¹⁾	
E	GWP	GWP	GWP	GWP	
F	SEER	SEER	SEER	SEER	
G	Energieffektivitetsklass (SEER)	Energiatohokuusluokka (SEER)	Energiatõhususe klass (SEER)	Energoefektivitātes klase (SEER)	
H	Q _{CE} ²⁾ (kylningssäsong)	Q _{CE} ²⁾ (jäähdytyskausi)	Q _{CE} ²⁾ (jahutamishooaeg)	Q _{CE} ²⁾ (dzēsēšanas sezonā)	
I	Pdesignc	Pdesignc	Pdesignc	Pdesignc	
J	SCOP (genomsnitt)	SCOP (keskimääräinen)	SCOP (keskmine)	SCOP (vidējā)	
K	Energieffektivitetsklass SCOP (genomsnitt)	Energiatohokuusluokka SCOP (keskimääräinen)	Energiatõhususe klass SCOP (keskmine)	Energoefektivitātes klase SCOP (vidējā)	
L	Q _{HE} ³⁾ uppvärmningssäsong (genomsnitt)	Q _{HE} ³⁾ lämmityskausi (keskimääräinen)	Q _{HE} ³⁾ kütmişooaeg (keskmine)	Q _{HE} ³⁾ sildīšanas sezonā (vidējā)	
M	Pdesignh (genomsnitt)	Pdesignh (keskimääräinen)	Pdesignh (keskmine)	Deklarētā sildīšanas slodze (vidējā)	
N	Backup-värmekapacitet (genomsnitt)	Varalämmitysteho (keskimääräinen)	Varukütte võimsus (keskmine)	Rezerves sildīšanas jauda (vidējā)	
O	Deklarerad kapacitet (genomsnitt)	Ilmoitettu teho (keskimääräinen)	Märgitud võimsus (keskmine)	Deklarētā jauda (vidējā)	
P	Andra passande uppvärmningssäsonger	Muut käytettävät lämmityskaudet	Muud sobivad kütmişooajad	Citas sildīšanas sezonas, kas piemērotas lietošanai	
Q	SCOP (varmare)	SCOP (lämmin)	SCOP (soojem)	SCOP (siltākā)	
R	Energieffektivitetsklass SCOP (varmare)	Energiatohokuusluokka SCOP (lämmin)	Energiatõhususe klass SCOP (soojem)	Energoefektivitātes klase SCOP (siltākā)	
S	Q _{HE} ³⁾ uppvärmningssäsong (varmare)	Q _{HE} ³⁾ lämmityskausi (lämmin)	Q _{HE} ³⁾ kütmişooaeg (soojem)	Q _{HE} ³⁾ sildīšanas sezonā (siltākā)	
T	Pdesignh (varmare)	Pdesignh (lämmin)	Pdesignh (soojem)	Deklarētā sildīšanas slodze (siltākā)	
U	Backup-värmekapacitet (varmare)	Varalämmitysteho (lämmin)	Varukütte võimsus (soojem)	Rezerves sildīšanas jauda (siltākā)	
V	Deklarerad kapacitet (varmare)	Ilmoitettu teho (lämmin)	Märgitud võimsus (soojem)	Deklarētā jauda (siltākā)	
W	SCOP (kallare)	SCOP (kylmä)	SCOP (külmem)	SCOP (aukstākā)	
X	Energieffektivitetsklass SCOP (kallare)	Energiatohokuusluokka SCOP (kylmä)	Energiatõhususe klass SCOP (külmem)	Energoefektivitātes klase SCOP (aukstākā)	
Y	Q _{HE} ³⁾ uppvärmningssäsong (kallare)	Q _{HE} ³⁾ lämmityskausi (kylmä)	Q _{HE} ³⁾ kütmişooaeg (külmem)	Q _{HE} ³⁾ sildīšanas sezonā (aukstākā)	
Z	Pdesignh (kallare)	Pdesignh (kylmä)	Pdesignh (külmem)	Deklarētā sildīšanas slodze (aukstākā)	
AA	Backup-värmekapacitet (kallare)	Varalämmitysteho (kylmä)	Varukütte võimsus (külmem)	Rezerves sildīšanas jauda (aukstākā)	
AB	Deklarerad kapacitet (kallare)	Ilmoitettu teho (kylmä)	Märgitud võimsus (külmem)	Deklarētā jauda (aukstākā)	
i	KOMMISSIONENS DELEGERADE FÖRORDNING (EU) nr 626/2011	DELEGOITU KOMISSION ASETUS (EU) N:o 626/2011	KOMISJONI DELEGEERITUD MÄÄRUS (EL) nr 626/2011	KOMISIJAS DELEĢĒTĀ REGULA (ES) NR. 626/2011	
ii	INFORMATIONSBLAGD OM PRODUKTEN (ENERGIMÄRKNING AV LUFTKONDITIONERINGSAPPARATER)	DELEGOITU KOMISSION ASETUS (EU) N:o 626/2011	TOOTEKAART (ÕHUKONDIIONEERIDE ENERGIAMÄRGISTUS)	DATU LAPA (GAISA KONDICIONĒTĀJU ENERĢOMĀRKĒJUMS)	
iii	kWh/år	kWh/a	kWh/a	kWh/a	
iv	Warmer	Varmare	Lämmin	Soojem	Siltākā
	Colder	Kallare	Kylmä	Külmem	Aukstākā
	Warmer & Colder	Varmare och kallare	Lämmin ja kylmä	Soojem ja külmem	Siltākā un aukstākā

	[LIETUVIŲ KALBA-LT]	[SRPSKI-SR]
A	Tiekėjo pavadinimas	Naziv dobavljača
B	Modelio pavadinimas (naudojamo patalpose / lauke)	Naziv modela (unutrašnja jedinica/spoljašnja jedinica)
C	Garso galios lygis (patalpose / lauke)	Nivo buke (unutrašnja/spoljna jedinica)
D	Šaldalo pavadinimas ¹⁾	Naziv rashladnog sredstva ¹⁾
E	GWP	GWP
F	SEER	SEER
G	Energijos suvartojimo efektyvumo klasė (SEER)	Klasa energetske efikasnosti (SEER)
H	$Q_{CE}^{2)}$ (vėsinimo sezonas)	$Q_{CE}^{2)}$ (sezona hlađenja)
I	Pdesignc	Pdesignc
J	SCOP (vidutinis klimatas)	SCOP (Prosečno)
K	Energijos suvartojimo efektyvumo klasė SCOP (vidutinis klimatas)	Klasa energetske efikasnosti SCOP (Prosečno)
L	$Q_{HE}^{3)}$ šildymo sezonas (vidutinis klimatas)	$Q_{HE}^{3)}$ grejna sezona (Prosečno)
M	Projektinė apkrova šildymo režimu (Pdesignh) (vidutinis klimatas)	Pdesignh (Prosečno)
N	Atsarginis šildymo pajėgumas (vidutinis klimatas)	Бацил ул капацитет грејања (Prosečno)
O	Projektinis pajėgumas (vidutinis klimatas)	Deklarisani kapacitet (Prosečno)
P	Kiti šildymo sezonai, kuriais tinkama naudoti	Druge grejne sezone pogodne za korišćenje
Q	SCOP (šiltesnis klimatas)	SCOP (Topliji deo godine)
R	Energijos suvartojimo efektyvumo klasė SCOP (šiltesnis klimatas)	Klasa energetske efikasnosti SCOP (Topliji deo godine)
S	$Q_{HE}^{3)}$ šildymo sezonas (šiltesnis klimatas)	$Q_{HE}^{3)}$ grejna sezona (Topliji deo godine)
T	Projektinė apkrova šildymo režimu (Pdesignh) (šiltesnis klimatas)	Pdesignh (Topliji deo godine)
U	Atsarginis šildymo pajėgumas (šiltesnis klimatas)	Бацил ул капацитет грејања (Topliji deo godine)
V	Projektinis pajėgumas (šiltesnis klimatas)	Deklarisani kapacitet (Topliji deo godine)
W	SCOP (šaltesnis klimatas)	SCOP (Hladniji deo godine)
X	Energijos suvartojimo efektyvumo klasė SCOP (šaltesnis klimatas)	Klasa energetske efikasnosti SCOP (Hladniji deo godine)
Y	$Q_{HE}^{3)}$ šildymo sezonas (šaltesnis klimatas)	$Q_{HE}^{3)}$ grejna sezona (Hladniji deo godine)
Z	Projektinė apkrova šildymo režimu (Pdesignh) (šaltesnis klimatas)	Pdesignh (Hladniji deo godine)
AA	Atsarginis šildymo pajėgumas (šaltesnis klimatas)	Бацил ул капацитет грејања (Hladniji deo godine)
AB	Projektinis pajėgumas (šaltesnis klimatas)	Deklarisani kapacitet (Hladniji deo godine)
i	KOMISIJOS DELEGUOTASIS REGLAMENTAS (ES) Nr. 626/2011	КОМИСИЈА ДЕЛЕГАТЕД УРЕДБА (ЕС) № 626/2011
ii	GAMINIO MIKROKORTA (ORO KONDICIONIERIŲ ENERGIJOS SUVARTOJIMO ŽENKLINIMAS)	ПРОИЗВОДА ФИЦХЕ (енергетског означавања клима уређаја)
iii	kWh/a	kWh/godišnje
iv	Warmer	Šiltesnis klimatas
	Colder	Šaltesnis klimatas
	Warmer & Colder	Šiltesnis ir šaltesnis klimatas
		Topliji deo godine
		Hladniji deo godine
		Topliji deo godine & Hladniji deo godine

Appendix

[ESPAÑOL-ES]

- 1 Las fugas de refrigerante contribuyen al cambio climático. Cuanto mayor sea el potencial de calentamiento global (GWP) de un refrigerante, más contribuirá a dicho calentamiento su vertido a la atmósfera. Este aparato contiene un líquido refrigerante con un GWP igual a [675].
Esto significa que, si pasara a la atmósfera 1 kg de este líquido refrigerante, el impacto en el calentamiento global sería, a lo largo de un periodo de 100 años, [675] veces mayor que si se vertiera 1 kg de CO₂. Nunca intente intervenir en el circuito del refrigerante ni desmontar el aparato usted mismo; consulte siempre a un profesional.
- 2 Consumo de energía "XYZ" kWh/año, según los resultados obtenidos en ensayos estándar. El consumo de energía real depende de las condiciones de uso del aparato y del lugar en el que esté instalado.
- 3 Consumo de energía "XYZ" kWh/año, según los resultados obtenidos en ensayos estándar. El consumo de energía real depende de las condiciones de uso del aparato y del lugar en el que esté instalado.

[FRANÇAIS-FR]

- 1 Les fuites de réfrigérants accentuent le changement climatique. En cas de fuite, l'impact sur le réchauffement de la planète sera d'autant plus limité que le potentiel de réchauffement planétaire (PRP) du réfrigérant est faible. Cet appareil utilise un réfrigérant dont le PRP est égal à [675].
En d'autres termes, si 1 kg de ce réfrigérant est relâché dans l'atmosphère, son impact sur le réchauffement de la planète sera [675] fois supérieure à celui d'1 kg de CO₂, sur une période de 100 ans. Ne tentez jamais d'intervenir dans le circuit frigorifique et de démonter les pièces vous-même et adressez-vous systématiquement à un professionnel.
- 2 Consommation d'énergie de "XYZ" kWh par an, déterminée sur la base des résultats obtenus dans des conditions d'essai normalisées. La consommation d'énergie réelle dépend des conditions d'utilisation et de l'emplacement de l'appareil.
- 3 Consommation d'énergie de "XYZ" kWh par an, déterminée sur la base des résultats obtenus dans des conditions d'essai normalisées. La consommation d'énergie réelle dépend des conditions d'utilisation et de l'emplacement de l'appareil.

[ITALIANO-IT]

- 1 La perdita di refrigerante contribuisce al cambiamento climatico. In caso di rilascio nell'atmosfera, i refrigeranti con un potenziale di riscaldamento globale (GWP) più basso contribuiscono in misura minore al riscaldamento globale rispetto a quelli con un GWP più elevato. Questo apparecchio contiene un fluido refrigerante con un GWP di [675].
Se 1 kg di questo fluido refrigerante fosse rilasciato nell'atmosfera, quindi, l'impatto sul riscaldamento globale sarebbe [675] volte più elevato rispetto a 1 kg di CO₂, per un periodo di 100 anni. In nessun caso l'utente deve cercare di intervenire sul circuito refrigerante o di disassemblare il prodotto. In caso di necessità occorre sempre rivolgersi a personale qualificato.
- 2 Consumo di energia "XYZ" kWh/anno in base ai risultati di prove standard. Il consumo effettivo dipende dalle modalità di utilizzo dell'apparecchio e dal luogo in cui è installato.
- 3 Consumo di energia "XYZ" kWh/anno in base ai risultati di prove standard. Il consumo effettivo dipende dalle modalità di utilizzo dell'apparecchio e dal luogo in cui è installato.

[PORTUGUÊS-PT]

- 1 A fuga de fluido refrigerante contribui para as alterações climáticas. Os fluidos refrigerantes com menor potencial de aquecimento global (PAG) contribuem menos para o aquecimento global do que os fluidos refrigerantes com maior PAG, em caso de fuga para a atmosfera. Este aparelho contém um fluido refrigerante com um PAG igual a [675].
Isto significa que, se ocorrer uma fuga de 1 kg deste fluido refrigerante para a atmosfera, o seu impacto no aquecimento global será [675] vezes mais elevado do que o de 1 kg de CO₂, durante um período de 100 anos. Nunca tome a iniciativa de intervir no circuito do fluido refrigerante ou de desmontar este produto; recorra sempre a um profissional.
- 2 Consumo de energia "XYZ" kWh por ano, com base nos resultados do teste normalizado. O valor real do consumo de energia dependerá do modo de utilização do aparelho e da sua localização.
- 3 Consumo de energia "XYZ" kWh por ano, com base nos resultados do teste normalizado. O valor real do consumo de energia dependerá do modo de utilização do aparelho e da sua localização.

[DEUTSCH-DE]

- 1 Der Austritt von Kältemittel trägt zum Klimawandel bei. Kältemittel mit geringerem Treibhauspotenzial tragen im Fall eines Austretens weniger zur Erderwärmung bei als solche mit höherem Treibhauspotenzial. Dieses Gerät enthält Kältemittel mit einem Treibhauspotenzial von [675].
Somit hätte ein Austreten von 1 kg dieses Kältemittels [675] Mal größere Auswirkungen auf die Erderwärmung als 1 kg CO₂, bezogen auf hundert Jahre. Keine Arbeiten am Kältekreislauf vornehmen oder das Gerät zerlegen – stets Fachpersonal hinzuziehen.
- 2 Energieverbrauch ‚XYZ‘ kWh/Jahr, auf der Grundlage von Ergebnissen der Normprüfung. Der tatsächliche Verbrauch hängt von der Nutzung und vom Standort des Geräts ab.
- 3 Energieverbrauch ‚XYZ‘ kWh/Jahr, auf der Grundlage von Ergebnissen der Normprüfung. Der tatsächliche Verbrauch hängt von der Nutzung und vom Standort des Geräts ab.

[ΕΛΛΗΝΙΚΑ-EL]

- 1 Διαρροή ψυκτικού μέσου συμβάλλει στην κλιματική αλλαγή. Εάν διαρρεύσει στην ατμόσφαιρα ψυκτικό μέσο με χαμηλότερο δυναμικό θέρμανσης του πλανήτη (GWP) θα συμβάλει λιγότερο στην υπερθέρμανση του πλανήτη από ψυκτικό με υψηλότερο GWP. Αυτή η συσκευή περιέχει ψυκτικό μέσο με GWP ίσο με [675].
Αυτό σημαίνει ότι εάν διαρρεύσει στην ατμόσφαιρα 1 kg του ψυκτικού μέσου, οι επιπτώσεις στην υπερθέρμανση του πλανήτη θα είναι [675] φορές μεγαλύτερες από 1 kg CO₂, σε περίοδο 100 ετών. Ποτέ μην επιχειρήσετε να επεμβείτε στο κύκλωμα ψυκτικού μέσου ή να αποσυναρμολογήσετε το προϊόν και πάντοτε να απευθύνεστε σε επαγγελματία.
- 2 Κατανάλωση ενέργειας “XYZ” kWh ετησίως, με βάση τα αποτελέσματα πρότυπης δοκιμής. Η πραγματική κατανάλωση ενέργειας εξαρτάται από τον τρόπο χρήσης και τη θέση της συσκευής.
- 3 Κατανάλωση ενέργειας “XYZ” kWh ετησίως, με βάση τα αποτελέσματα πρότυπης δοκιμής. Η πραγματική κατανάλωση ενέργειας εξαρτάται από τον τρόπο χρήσης και τη θέση της συσκευής.

[NEDERLANDS-NL]

- 1 Lekken van koelmiddel dragen bij tot de klimaatveranderingen. Koelmiddelen met een lager Global Warming Potential (GWP) dragen minder bij tot de klimaatveranderingen dan een koelmiddel met een hogere GWP, indien ze in de atmosfeer vrijkomen. Dit apparaat bevat een koelmiddel met een GWP van [675].
Dit betekent dat als 1 kg van deze koelstof in de atmosfeer zou lekken, de invloed hiervan op de klimaatveranderingen [675] keer zo hoog zou zijn als 1 kg CO₂, over een periode van 100 jaar. Probeer nooit zelf het koelcircuit te repareren of het product te demonteren, schakel altijd een professional in.
- 2 Energieverbruik ‘XYZ’ kWh per jaar, op basis van de standaard testresultaten. Het werkelijke energieverbruik is afhankelijk van het gebruik en de locatie van het apparaat.
- 3 Energieverbruik ‘XYZ’ kWh per jaar, op basis van de standaard testresultaten. Het werkelijke energieverbruik is afhankelijk van het gebruik en de locatie van het apparaat.

[POLSKI-PL]

- 1 Wycieki środka chłodzącego przyczyniają się do zmiany klimatu. W przypadku dostania się do atmosfery środek o niższym potencjale tworzenia efektu cieplarnianego (GWP) przyczynia się do powstawania zjawiska globalnego ocieplenia w mniejszym stopniu niż środki o wyższym GWP. To urządzenie zawiera płynny środek chłodzący o potencjale tworzenia efektu cieplarnianego równym [675].
Oznacza to, że w okresie 100 lat w przypadku wycieku do atmosfery 1 kg tego płynnego środka efekt takiego wycieku będzie [675] mocniej odczuwalny niż w przypadku dostania się do atmosfery 1 kg CO₂. Nigdy nie należy próbować samodzielnie ingerować w obieg środka chłodzącego ani demontować samodzielnie produktu – należy zawsze skorzystać z pomocy profesjonalisty.
- 2 Roczny pobór mocy wynosi zgodnie ze standardowym testem „XYZ” kWh. Rzeczywisty pobór energii zależy od sposobu, w jaki jest wykorzystywane urządzenie oraz od lokalizacji, w której jest użytkowane.
- 3 Roczny pobór mocy wynosi zgodnie ze standardowym testem „XYZ” kWh. Rzeczywisty pobór energii zależy od sposobu, w jaki jest wykorzystywane urządzenie oraz od lokalizacji, w której jest użytkowane.

Appendix

[MAGYAR-HU]

- 1 A hűtőközeg-szivárgás fokozza az éghajlatváltozást. Az alacsonyabb globális felmelegedési potenciállal (GWP) rendelkező hűtőközegek kevésbé járulnak hozzá a globális felmelegedéshez, ha a légkörbe jutnak, mint a magasabb együttthatójú típusok. A berendezés [675] értékű globális felmelegedési potenciállal (GWP) rendelkező, folyékony halmazállapotú hűtőközeget tartalmaz.
Ez azt jelenti, hogy ha 1 kg ilyen típusú hűtőközeg a légkörbe kerül, annak globális felmelegedésre gyakorolt hatása 100 éves időszakra kivetítve [675]-szor lenne nagyobb annál, mintha 1 kg CO₂ szivárgott volna a légkörbe. Soha ne próbálja meg saját kezűleg szétszerelni a berendezést, vagy megbontani annak hűtőkörét! Forduljon mindig szakemberhez.
- 2 Energiafogyasztás: „XYZ” kWh/év, szabványos vizsgálati eredmények alapján. A tényleges energiafogyasztás a felhasználás módjától és a berendezés elhelyezésétől függ.
- 3 Energiafogyasztás: „XYZ” kWh/év, szabványos vizsgálati eredmények alapján. A tényleges energiafogyasztás a felhasználás módjától és a berendezés elhelyezésétől függ.

[ČEŠTINA-CS]

- 1 Dopady úniků chladiva na klimatické změny. Chladivo s nižším potenciálem globálního oteplování (GWP) má v případě úniku do ovzduší menší vliv na globální oteplování než chladivo s vyšším GWP. Zařízení obsahuje chladicí kapalinu s GWP, který odpovídá hodnotě [675].
To znamená, že když do ovzduší unikne 1 kg této chladicí kapaliny, dopad na globální oteplování po dobu 100 let je 675krát vyšší než u 1 kg CO₂. Nikdy se nesnažte do chladicího okruhu sami zasahovat ani sami produkt rozebírat, vždy se obraťte na odborníka.
- 2 Roční spotřeba energie je na základě výsledků běžných testů činí „XYZ” kWh. Skutečná spotřeba energie závisí na způsobu používání a umístění zařízení.
- 3 oční spotřeba energie je na základě výsledků běžných testů činí „XYZ” kWh. Skutečná spotřeba energie závisí na způsobu používání a umístění zařízení.

[SLOVENČINA-SK]

- 1 Úniky chladiva prispievajú k zmene klímy. Chladivo s nižším potenciálom prispievania ku globálnemu oteplovaniu (GWP) by pri úniku do atmosféry prispelo ku globálnemu oteplovaniu v nižšej miere ako chladivo s vyšším GWP. Toto zariadenie obsahuje chladiacu kvapalinu s GWP rovnajúcim sa [675].
Znamená to, že ak by do atmosféry unikol 1 kg tejto chladiacej kvapaliny, jej vplyv na globálne otepľovanie by bol [675] krát vyšší ako vplyv 1 kg CO₂, a to počas obdobia 100 rokov. Nikdy sa nepokúšajte zasahovať do chladiaceho okruhu alebo demontovať výrobok a vždy sa obráťte na odborníka.
- 2 Spotřeba energie XYZ kWh za rok na základe výsledkov štandardného preskúšania. Skutočná spotřeba energie bude závisieť od toho, ako sa zariadenie používa a kde je umiestnené.
- 3 Spotřeba energie XYZ kWh za rok na základe výsledkov štandardného preskúšania. Skutočná spotřeba energie bude závisieť od toho, ako sa zariadenie používa a kde je umiestnené.

[ROMÂNĂ-RO]

- 1 Scurgerea de agent frigorific contribuie la schimbările climatice. Agentul frigorific cu potențial de încălzire globală (GWP) mai scăzut va contribui mai puțin la încălzirea globală decât un agent frigorific cu GWP mai ridicat. Acest aparat conține un agent frigorific lichid cu GWP egal cu [675].
Asta înseamnă că, dacă 1 kg din acest agent frigorific lichid se scurge în atmosferă, impactul asupra încălzirii globale va fi de [675] ori mai ridicat decât pentru 1 kg de CO₂, pe o perioadă de 100 de ani. Nu încercați niciodată să interveniți la circuitul agentului frigorific sau să demontați dvs. produsul, ci solicitați întotdeauna ajutorul unui profesionist.
- 2 Consum de energie de „XYZ” kWh pe an, pe baza rezultatelor testelor standard. Consumul efectiv de energie va depinde de modul în care este utilizat aparatul și locul în care este plasat acesta.
- 3 Consum de energie de „XYZ” kWh pe an, pe baza rezultatelor testelor standard. Consumul efectiv de energie va depinde de modul în care este utilizat aparatul și locul în care este plasat acesta.

[БЪЛГАРСКИ-BG]

- 1 Течовете на хладилен агент допринасят за изменението на климата. Хладилен агент с по-нисък потенциал за глобално затопляне (GWP) би допринесъл по-малко за глобалното затопляне, отколкото хладилен агент с по-висок GWP, в случай на изтичане в атмосферата. Този уред съдържа течен хладилен агент с GWP, равен на [675]. Това означава, че ако 1 kg от този течен хладилен агент изтече в атмосферата, въздействието върху глобалното затопляне би било [675] пъти по-високо от 1 kg CO₂ за период от 100 години. Никога не се опитвайте сами да влияете върху веригата на хладилния агент или сами да разглобявате продукта, а винаги търсете специалист.
- 2 Потрошња енергије „XYZ“ kWh годишње, на osnovu rezultata standardnog testa. Stvarna potrošnja energije zavisi od toga kako se uređaj koristi i gde je smešten. Никога не се опитвайте сами да влияете върху веригата на хладилния агент или сами да разглобявате продукта, а винаги търсете специалист.
- 3 Консумация на енергия „XYZ“ kWh на година в зависимост от резултатите от стандартни изпитвания. Действителната консумация на енергия ще зависи от начина на използване на уреда и от местоположението му.

[HRVATSKI-HR]

- 1 Istjecanje rashladnih sredstava doprinosi klimatskim promjenama. U slučaju ispuštanja u atmosferu rashladno sredstvo s nižim potencijalom globalnog zagrijavanja (GWP) manje bi utjecalo na globalno zagrijavanje od rashladnog sredstva s višim GWP-om. Taj uređaj sadrži rashladnu tekućinu s GWP-om jednakim [675]. To znači da bi u slučaju istjecanja 1 kg te rashladne tekućine u atmosferu, njezin utjecaj na globalno zagrijavanje bio [675] puta veći od utjecaja 1 kg CO₂ tijekom razdoblja od 100 godina. Nikada sami ne pokušavajte raditi bilo kakve zahvate na rashladnom krugu niti rastavljati proizvod i za to uvijek zovite profesionalca.
- 2 Potrošnja energije XYZ kWh na godinu, na temelju rezultata standardnih ispitivanja. Stvarna potrošnja energije ovisi o načinu uporabe uređaja i o mjestu na kojem se nalazi.
- 3 Potrošnja energije XYZ kWh na godinu, na temelju rezultata standardnih ispitivanja. Stvarna potrošnja energije ovisi o načinu uporabe uređaja i o mjestu na kojem se nalazi.

[SLOVENČINA-SL]

- 1 Úniky chladiva prispievajú k zmene klímy. Chladivo s nižším potenciálom prispievania ku globálnemu otepľovaniu (GWP) by pri úniku do atmosféry prispelo ku globálnemu otepľovaniu v nižšej miere ako chladivo s vyšším GWP. Toto zariadenie obsahuje chladiacu kvapalinu s GWP rovnajúcim sa [675]. Znamená to, že ak by do atmosféry unikol 1 kg tejto chladiacej kvapaliny, jej vplyv na globálne otepľovanie by bol [675] krát vyšší ako vplyv 1 kg CO₂, a to počas obdobia 100 rokov. Nikdy sa nepokúšajte zasahovať do chladiaceho okruhu alebo demontovať výrobok a vždy sa obráťte na odborníka.
- 2 Spotreba energie XYZ kWh za rok na základe výsledkov štandardného preskúšania. Skutočná spotreba energie bude závisieť od toho, ako sa zariadenie používa a kde je umiestnené.
- 3 Spotreba energie XYZ kWh za rok na základe výsledkov štandardného preskúšania. Skutočná spotreba energie bude závisieť od toho, ako sa zariadenie používa a kde je umiestnené.

[DANSK-DA]

- 1 Udsivning fra køleelementet er medvirkende til klimaforandringerne. Kølelementer med et lavere globalt opvarmningspotentiale (GWP) bidrager mindre til den globale opvarmning end kølelementer med et højere GWP, hvis der er udsivning i atmosfæren. Denne enhed indeholder et kølemiddel med et GWP, der svarer til [675]. Det betyder, at hvis der udsiver 1 kg kølemiddel i atmosfæren, kan indvirkningen på den globale opvarmning være [675] gange højere end 1 kg CO₂ over en periode på 100 år. Du må ikke selv foretage ændringer i køleelementets kredsløb eller forsøge at demontere produktet. Du skal altid kontakte en fagmand.
- 2 Energiforbrug "XYZ" kWh pr. år er baseret på standardprøveresultater. Det faktiske energiforbrug afhænger af, hvordan enheden anvendes og placeringen af enheden.
- 3 Energiforbrug "XYZ" kWh pr. år er baseret på standardprøveresultater. Det faktiske energiforbrug afhænger af, hvordan enheden anvendes og placeringen af enheden.

Appendix

[SVENSKA-SV]

- 1 Läckande köldmedium bidrar till klimatförändringen. Köldmedier med lägre global uppvärmningspotential (GWP) bidrar mindre till den globala uppvärmningen än köldmedier med högre GWP-värde, om de skulle läcka ut i atmosfären. Den här enheten innehåller ett köldmedium med ett GWP-värde som är lika med [675]. Detta innebär att om 1 kg av detta köldmedium skulle läcka ut i atmosfären skulle köldmediets påverkan på den globala uppvärmningen vara [675] gånger högre än 1 kg CO₂ under en period om 100 år. Försök aldrig att göra förändringar i köldmedieslingan eller montera isär produkten på egen hand. Kontakta alltid en fackman.
- 2 Energiförbrukningen "XYZ" kWh per år baserat på standardiserade testresultat. Den faktiska energiförbrukningen beror på hur apparaten används och var den placeras.
- 3 Energiförbrukningen "XYZ" kWh per år baserat på standardiserade testresultat. Den faktiska energiförbrukningen beror på hur apparaten används och var den placeras.

[SUOMI-FI]

- 1 Kylmäainevuodot vaikuttavat ilmastonmuutokseen. Kylmäaineen, jolla on alhaisempi ilmakehän lämmitysvaikutuspotentiaali (GWP), ilmastonmuutosvaikutus olisi pienempi kuin korkeamman GWP-arvon kylmäaineen, jos kylmäainetta pääsisi ilmakehään. Tämä laite sisältää kylmäainetta, jonka GWP-arvo on [675]. Tämä tarkoittaa, että jos yksi kilo tätä kylmäainetta pääsisi ilmakehään, sen vaikutus ilmaston lämpenemiseen olisi [675] kertaa suurempi kuin yhdellä kilolla hiilidioksidia 100 vuoden ajanjaksolla. Älä koskaan yritä kajota kylmäainepiiriin tai purkaa tuotetta omin päin, vaan pyydä aina ammattilaisen apua.
- 2 Energiankulutus 'XYZ' kWh vuodessa laskettuna vakio-olosuhteissa. Tosiasiallinen energiankulutus riippuu laitteen käyttötavoista ja laitteen sijoituksesta.
- 3 Energiankulutus 'XYZ' kWh vuodessa laskettuna vakio-olosuhteissa. Tosiasiallinen energiankulutus riippuu laitteen käyttötavoista ja laitteen sijoituksesta.

[EESTI-ET]

- 1 Jahutusaine lekkimine soodustab kliimamuutust. Väiksema globaalse soojenemise potentsiaaliga jahutusaine soodustab atmosfääri lekkimise korral globaalset soojenemist vähem kui suurema globaalse soojenemise potentsiaaliga jahutusaine. See seade sisaldab jahutusainet, mille globaalse soojenemise potentsiaal on [675]. See tähendab, et kui 1 kg jahutusvedelikku lekiks atmosfääri, oleks selle mõju globaalsele soojenemisele 100 aasta jooksul [675] korda suurem kui 1 kg CO₂ lekkimise korral. Ärge püüdke kunagi jahutusvedeliku ringet ise muuta ega toodet koost lahti võtta, vaid paluge alati professionaali abi.
- 2 Energiatarbimine XYZ kWh aastas standardsete testide tulemuste põhjal. Tegelik energiatarbimine oleneb seadme kasutamisest ja asukohast.
- 3 Energiatarbimine XYZ kWh aastas standardsete testide tulemuste põhjal. Tegelik energiatarbimine oleneb seadme kasutamisest ja asukohast.

[LATVIEŠU-LV]

- 1 Aukstumaģenta noplūde veicina klimata pārmaiņas. Aukstumaģents ar zemāku globālās sasilšanas potenciālu (GWP) globālo sasilšanu veicina mazākā mērā nekā aukstumaģents ar augstāku GWP, ja notiek noplūde atmosfērā. Šajā iekārtā izmantots aukstumaģenta šķidrums, kura GWP atbilst [675]. Tas nozīmē, ka gadījumā, ja atmosfērā noplūstu 1 kg šī aukstumaģenta šķidruma, ietekme uz globālo sasilšanu 100 gadu laika posmā būtu [675] reizes lielāka, salīdzinot ar 1 kg CO₂. Nekādā gadījumā nemēģiniet iejaukties aukstumaģenta kontūrā vai izjaukt izstrādājumu. Vienmēr griezieties pie speciālista.
- 2 Enerģijas patēriņš "XYZ" kWh gadā, pamatojoties uz standarta testa rezultātiem. Faktiskais enerģijas patēriņš ir atkarīgs no iekārtas lietošanas veida un tās atrašanās vietas.
- 3 Enerģijas patēriņš "XYZ" kWh gadā, pamatojoties uz standarta testa rezultātiem. Faktiskais enerģijas patēriņš ir atkarīgs no iekārtas lietošanas veida un tās atrašanās vietas.

[LIETUVIŲ KALBA-LT]

- 1 Šaldalo protēkis turi ītakos klimato kaitai. Į atmosferą ištekėjęs šaldalas, kurio globalinis šiltėjimo potencialas (GWP) mažesnis, globaliniam atšilimui turi mažiau įtakos nei šaldalas, kurio GWP didesnis. Šiame prietaise yra šaldymo skysčio, kurio GWP lygus [675]. Tai reiškia, kad į atmosferą patekus 1 kg šio šaldymo skysčio, įtaka globaliniam atšilimui būtų [675] kartus didesnė nei patekus 1 kg CO₂ (per 100 metų laikotarpį). Niekada nebandykite patys taisyti šaldymo grandinės arba ardyti gaminio – visada prašykite, kad tai atliktų specialistas.
- 2 „XYZ“ kWh energijos suvartojimo per metus duomenys pagrįsti standartinio bandymo rezultatais. Faktinis energijos suvartojimas priklauso nuo to, kaip prietaisas naudojamas ir kokioje vietoje jis yra.
- 3 „XYZ“ kWh energijos suvartojimo per metus duomenys pagrįsti standartinio bandymo rezultatais. Faktinis energijos suvartojimas priklauso nuo to, kaip prietaisas naudojamas ir kokioje vietoje jis yra.

[SRPSKI-SR]

- 1 Curenje rashladnog sredstva doprinosi klimatskim promenama. Ako iscuri u atmosferu, rashladno sredstvo s nižim potencijalom globalnog zagrevanja (GWP) manje će doprineti globalnom zagrevanju nego rashladno sredstvo sa višim potencijalom globalnog zagrevanja. Ovaj uređaj sadrži rashladnu tečnost sa vrednošću GWP od [675]. To znači da, ako 1 kg ove rashladne tečnosti iscuri u atmosferu, uticaj na globalno zagrevanje će biti [675] puta veći nego da iscuri 1 kg CO₂, posmatrano u periodu od 100 godina. Ne pokušavajte sami da zamenite rashladno sredstvo niti da rasklopite proizvod, već uvek zatražite pomoć stručnjaka.
- 2 Potrošnja energije „XYZ“ kWh godišnje, na osnovu rezultata standardnog testa. Stvarna potrošnja energije zavisi od toga kako se uređaj koristi i gde je smešten.
- 3 Potrošnja energije „XYZ“ kWh godišnje, na osnovu rezultata standardnog testa. Stvarna potrošnja energije zavisi od toga kako se uređaj koristi i gde je smešten.

SAMSUNG ELECTRONICS CO., LTD .
107, Hanamsandan 6beon-ro, Gwangsan-gu, Gwangju-si, Korea 62218

Samsung Electronics
Service Department
PO Box 12987, Blackrock, Co. Dublin. Ireland
or
Blackbushe Business Park, Yateley, GU46 6GG. UK



This appliance is filled with R-32.